

INSTALLATION MANUAL

FIRE SEALING IN CLT CONSTRUCTIONS

(cross-laminated timber constructions)

Fire stopping System Hand Book

FIRESAFE /

Date: 19.11.2021

Author: Pål Paulsen

Controlled by: Hallvard K Engøy

Rev.: 01



Product documentation:

Norway: RISEFR 030-0309

RISE Fire Research AS

RISE Research Institutes of Sweden

NO	S	DK	EN	ET	FIN
			✓		

INTRODUCTION

This installation guide applies to Fire Stopping for installation penetrations, as well as linear joints in CLT (cross-laminated timber) structures. Tested solutions comprise of a selection of FIRESAFE products that can be used in combination with each other. Openings for installation penetrations have predominately been tested as circular openings, as is the practice in buildings that use CLT structures. This also applies to tested solutions for rectangular openings in CLT.

THIS INSTALLATION GUIDE APPLIES TO THE FOLLOWING FIRESAFE PRODUCTS:

- FIRESAFE KL-reserve PVC cable conduit.
- FIRESAFE FT Acrylic.
- FIRESAFE FT Graphite.
- FIRESAFE GPG MORTAR.
- FIRESAFE FIRE WRAP.
- FIRESAFE FIRE COLLAR.
- FIRESAFE WRAP LX.
- FIRESAFE EX Heat-expanding sealant.

CERTIFICATION / FIRE RESISTANCE

- FIRESAFE products are tested in accordance with NS-EN 1366-3 (2009) and 1366-4 (2009), as well as EN 13501-1/2.
- Certified in accordance with ETA (European Technical Assessment), as well as national product documentation issued by RISE Fire Research AS.
- Fire resistance EI 30 to EI 90 with extensive areas of application for walls and floors.
- Fire classification of CLT walls in accordance with EN-1363-1.: CLT walls (density 420 kg/m³) thickness ≥ 100 mm.
- Fire classification of CLT floor slabs in accordance with EN-1363-1.: CLT floor slabs (density 420 kg/m³) thickness ≥ 140 mm.
- CLT floor slabs with EPS thermal insulation (which is combustible) – mineral wool sound attenuation panels – concrete screed. Thickness ≥ 270 mm.

APPLICATION/INSTALLATION.

- See subsequent pages for installation details.

EXPLANATION OF SOLUTIONS FOR DIFFERENT SIZE HOLES.

- See pages 97–101.

EXPLANATIONS OF ABBREVIATIONS FOR PIPE INSULATION (see NS-EN 1366-3: 2009. Table 1).

- See page 102.

EXPLANATIONS OF ABBREVIATIONS FOR PIPE END CONFIGURATIONS (see NS-EN 1366-3: Table 2009).

- See page 102.

GENERAL RULES FOR DISTANCES AND OTHER TECHNICAL INFORMATION.

- See page 102.

SUSPENSION SYSTEMS AND DISTANCES (ref. NS-EN 1366-3: Table 2009).

- See page 103.

PRINCIPLES FOR THE CONSTRUCTION OF A CLT FLOOR SLAB WITH THERMAL INSULATION AND SCREED.

- See page 103.

HOW TO MEASURE SEALANT DEPTH WITH FIRESAFE FT Acrylic, FIRESAFE FT Graphite and FIRESAFE EX Heat-expanding sealant.

- See page 104.

INSULATION OF PIPES AND VENTILATION DUCTS, AS WELL AS REQUIREMENTS FOR CORROSION PROTECTION OF METAL PIPES.

- See page 104.

INSTALLATION MANUAL

FIRE SEALING IN CLT CONSTRUCTIONS

Fire Stopping System Hand Book

FIRESAFE

Date: 19.11.2021

Prepared by: Pål Paulsen

Controlled by: Hallvard K Engøy

Rev.: 01

TYPE OF INSTALLATION AND FIRE STOPPING PRODUCT	FIRE RESISTANCE	DETAILS	PAGE
Product: FIRESAFE KL-RESERVE PVC CABLE CONDUIT Ø 32–50 mm			7
FIRESAFE KL-reserve PVC cable conduit Ø 32–50 mm. Cable (d) ≤ 2 pcs Ø 21 mm. CLT wall ≥ 100 mm.	E 90 – EI 90	Figure 1	8
FIRESAFE KL-reserve PVC cable conduit Ø 32–50 mm. Cable (d) ≤ 2 pcs Ø 21 mm. CLT floor slab ≥ 140 mm.	E 90 – EI 90	Figure 2	9

TYPE OF INSTALLATION AND FIRE STOPPING PRODUCT	FIRE RESISTANCE	DETAILS	PAGE
Product: FIRESAFE FT ACRYLIC			10
Corrugated electrical cable conduit of PVC-U plastic. (d) ≤ Ø 32 mm. C/C. CLT wall ≥ 100 mm.	E 90 – EI 60	Figure 3	11
Corrugated electrical cable conduit of PVC-U plastic. (d) ≤ Ø 32 mm. C/C. CLT floor slab ≥ 140 mm.	E 90 – EI 90	Figure 4	12
Smooth electrical cable conduit of PVC-U plastic. (d) ≤ Ø 32 mm. C/C. CLT wall ≥ 100 mm.	E 90 – EI 90	Figure 5	13
Smooth electrical cable conduit of PVC-U plastic. (d) ≤ Ø 32 mm. C/C. CLT floor slab ≥ 140 mm.	E 90 – EI 90	Figure 6	14
Cable bundle (d) ≤ Ø 90 mm, cable (d) ≤ Ø 21 mm. CLT wall ≥ 100 mm.	E 90 – EI 90	Figure 7	15
Cable bundle (d) ≤ Ø 90 mm, cable (d) ≤ Ø 21 mm. CLT floor slab ≥ 140 mm.	E 90 – EI 90	Figure 8	16
Pipe-in-pipe type PE-X (d) ≤ OD Ø 25 mm ID ≤ Ø 16 mm. C/C. CLT wall ≥ 100 mm.	E 90 – EI 90	Figure 9	17
Pipe-in-pipe type PE-X (d) ≤ OD Ø 25 mm ID ≤ Ø 16 mm. C/C. CLT floor slab ≥ 140 mm.	E 90 – EI 90	Figure 10	18
Aluminium pipe type alu PE-X (d) ≤ Ø 25 mm, (t) 2.25 mm. 13 mm Armaflex AF. C/C. CLT wall ≥ 100 mm.	E 90 – EI 90	Figure 11	19
Cast iron pipe (d) ≤ Ø 58 mm, (t) 3.5 mm. 20 mm PAROC Hvac Section AluCoat T. C/U. CLT wall ≥ 100 mm.	E 90 – EI 90	Figure 12	20
Cast iron pipe (d) ≤ Ø 58 mm, (t) 3.5 mm. 20 mm PAROC Hvac Section AluCoat T. C/U. CLT floor slab ≥ 140 mm.	E 90 – EI 90	Figure 13	21
Cast iron pipe (d) ≤ Ø 110 mm, (t) 3.5 mm. 30 mm PAROC Hvac Section AluCoat T. C/U. CLT wall ≥ 100 mm.	E 90 – EI 90	Figure 14	22
Cast iron pipe (d) ≤ Ø 110 mm, (t) 3.5 mm. 30 mm PAROC Hvac Section AluCoat T. C/U. CLT floor slab ≥ 140 mm.	E 90 – EI 90	Figure 15	23
Ventilation duct (d) ≤ Ø 300 mm, (t) 0.9 mm. 30 mm PAROC Hvac Section Fire Mat. C/U. CLT wall ≥ 100 mm.	E 90 – EI 60	Figure 16	24
Ventilation duct (d) ≤ Ø 300 mm, (t) 0.9 mm. 30 mm PAROC Hvac Section Fire Mat. C/U. CLT floor slab ≥ 140 mm.	E 90 – EI 90	Figure 17	25
Linear joints. Vertical width ≤ 20 mm. CLT wall ≥ 100 mm.	E 90 – EI 90	Figure 18	26
Linear joints. Horizontal ≤ 20 mm. CLT wall ≥ 100 mm.	E 90 – EI 90	Figure 19	27

FIRESAFE

All information in this data sheet is to be regarded as normative values obtained from tests and our collective knowledge and experience of the product. This data must not be used as a basis for or verification of other tests or systems. Firesafe AS accepts no liability for other use or misuse of the product. Users are responsible for ensuring they use the latest version of this document. Please check our website www.firesafe.no. This document may not be copied without the written consent of Firesafe AS.

TYPE OF INSTALLATION AND FIRE STOPPING PRODUCT	FIRE RESISTANCE	DETAILS	PAGE
Product: FIRESAFE FT GRAPHITE			28
Cable bundle (d) ≤ Ø 100 mm, cable (d) ≤ Ø 21 mm. CLT wall ≥ 100 mm.	E 90 – EI 90	Figure 20	29
Cable bundle (d) ≤ Ø 100 mm, cable (d) ≤ Ø 21 mm. CLT floor slab ≥ 140 mm.	E 90 – EI 90	Figure 21	30
Electrical cable conduit bundle of PVC-U plastic (d) ≤ Ø 110 mm, corrugated or smooth. C/C. CLT wall ≥ 100 mm.	E 90 – EI 90	Figure 22	31
Electrical cable conduit bundle of PVC-U plastic (d) ≤ Ø 110 mm, corrugated or smooth. C/C. CLT floor slab ≥ 140 mm.	E 90 – EI 90	Figure 23	32
PE plastic pipe (d) ≤ Ø 110 mm, (t) 3.4 mm. U/C. CLT wall ≥ 100 mm.	E 90 – EI 90	Figure 24	33
PE plastic pipe (d) ≤ Ø 110 mm, (t) 3.4 mm. U/C. CLT floor slab ≥ 140 mm.	E 90 – EI 90	Figure 25	34
PP plastic pipe (d) ≤ Ø 110 mm, (t) 6.3 mm. U/C. CLT wall ≥ 100 mm.	E 90 – EI 90	Figure 26	35
PP plastic pipe (d) ≤ Ø 110 mm, (t) 6.3 mm. U/C. CLT floor slab ≥ 140 mm.	E 90 – EI 90	Figure 27	36
Copper and steel pipes (d) ≤ Ø 12 mm, (t) 1.0 mm. 13 mm Armaflex AF. C/U. CLT floor slab ≥ 140 mm.	E 90 – EI 90	Figure 28	37
Copper and steel pipes (d) ≤ Ø 76 mm, (t) 2.0 mm. 13 mm Armaflex AF. C/U. CLT floor slab ≥ 140 mm.	E 90 – EI 30	Figure 29	38
Aluminium pipe type alu PE-X (d) ≤ Ø 16 mm, (t) 2.25 mm. 13 mm Armaflex AF. U/C. CLT floor slab ≥ 140 mm.	E 90 – EI 90	Figure 30	39
Aluminium pipe type alu PE-X (d) ≤ Ø 63 mm, (t) 4.5 mm. 13 mm Armaflex AF. U/C. CLT floor slab ≥ 140 mm.	E 90 – EI 90	Figure 31	40
Steel pipe (d) ≤ Ø 42 mm, (t) 2.6 mm. 13 mm Armaflex AF. C/U. CLT floor slab ≥ 140 mm.	E 90 – EI 90	Figure 32	41
Steel pipe (d) ≤ Ø 89.9 mm, (t) 3.0 mm. 13 mm Armaflex AF. C/U. CLT floor slab ≥ 140 mm.	E 90 – EI 90	Figure 33	42

INSTALLATION MANUAL

FIRE SEALING IN CLT CONSTRUCTIONS

Fire Stopping System Hand Book

FIRESAFE

Date: 19.11.2021

Prepared by: Pål Paulsen

Controlled by: Hallvard K Engøy

Rev.: 01

TYPE OF INSTALLATION AND FIRE STOPPING PRODUCT	FIRE RESISTANCE	DETAILS	PAGE
Product: FIRESAFE GPG MORTAR			43
Cable bundle (d) ≤ Ø 80 mm, cable (d) ≤ Ø 21 mm. CLT wall ≥ 100 mm.	E 90 – EI 90	Figure 34	44
Cable bundle (d) ≤ Ø 80 mm, cable (d) ≤ Ø 21 mm. CLT floor slab ≥ 140 mm.	E 90 – EI 90	Figure 35	45
Multiple cables, cable (d) ≤ Ø 50 mm. CLT wall ≥ 100 mm.	E 90 – EI 60	Figure 36	46
Multiple cables, cable (d) ≤ Ø 50 mm. CLT floor slab ≥ 140 mm.	E 90 – EI 90	Figure 37	47
Ventilation duct (d) ≤ Ø 300 mm, (t) 0.9 mm. 30 mm PAROC Hvac Section Fire Mat. C/U. CLT wall ≥ 100 mm.	E 90 – EI 60	Figure 38	48
Ventilation duct (d) ≤ Ø 300 mm, (t) 0.9 mm. 30 mm PAROC Hvac Section Fire Mat. C/U. CLT floor slab ≥ 140 mm.	E 90 – EI 90	Figure 39	49
Unused aperture ≤ 200 x 140 mm. Sealing from two sides. CLT wall ≥ 100 mm.	E 90 – EI 90	Figure 40	50
Unused aperture ≤ 200 x 140 mm. Sealing from two sides. CLT floor slab ≥ 140 mm.	E 90 – EI 90	Figure 41	51
Unused aperture ≤ Ø 140 mm. Sealing from one side. CLT wall ≥ 100 mm.	E 90 – EI 60	Figure 42	52
Unused aperture ≤ Ø 140 mm. Sealing from one side, unexposed side. CLT floor slab ≥ 140 mm.	E 90 – EI 90	Figure 43	53
Cast iron pipe (d) ≤ Ø 110 mm, (t) 3.5 mm. C/U. CLT floor slab ≥ 140 mm.	E 90 – EI 60	Figure 44	54
Cast iron pipe (d) ≤ Ø 58 mm, (t) 3.5 mm. C/U. CLT floor slab ≥ 140 mm and EPS thermal insulation – mineral wool – concrete screed.	E 90 – EI 90	Figure 45	55
Cast iron pipe (d) ≤ Ø 110 mm, (t) 3.5 mm. C/U. CLT floor slab ≥ 140 mm and EPS thermal insulation – mineral wool – concrete screed.	E 90 – EI 90	Figure 46	56
Floor drain PURUS Joti KS (cast iron). Cast iron drain pipe (d) ≤ Ø 75 mm, (t) 3.5 mm. C/C. CLT floor slab ≥ 140 mm and EPS thermal insulation – mineral wool – concrete screed.	E 90 – EI 90	Figure 47	57
Floor drain PURUS Joti Balder 75 R (stainless). Cast iron drain pipe (d) ≤ Ø 75 mm, (t) 3.5 mm. C/C. CLT floor slab ≥ 140 mm and EPS thermal insulation – mineral wool – concrete screed.	E 90 – EI 90	Figure 48	58
Floor drain PURUS Joti K drain (PP plastic). PP plastic drain pipe (d) ≤ Ø 75 mm, (t) 2.6 mm. C/C. FIRE COLLAR. CLT floor slab ≥ 140 mm and EPS thermal insulation – mineral wool – concrete screed.	E 90 – EI 90	Figure 49	59
Floor drain PURUS Joti K drain (PP plastic). PP plastic drain pipe (d) ≤ Ø 75 mm, (t) 2.6 mm. C/C. FIRE WRAP. CLT floor slab ≥ 140 mm and EPS thermal insulation – mineral wool – concrete screed.	E 90 – EI 90	Figure 50	60
PP-MD plastic pipe (d) ≤ Ø 110 mm, (t) 3.8 mm. U/C. FIRE WRAP. CLT floor slab ≥ 140 mm.	E 90 – EI 90	Figure 51	61
PP-MD plastic pipe (d) ≤ Ø 110 mm, (t) 3.8 mm. Pipe at an angle of 45°. U/C. FIRE COLLAR. CLT floor slab ≥ 140 mm.	E 90 – EI 90	Figure 52	62
PP-MD plastic pipe (d) ≤ Ø 110 mm, (t) 3.8 mm. U/C. FIRE COLLAR. CLT floor slab ≥ 140 mm.	E 90 – EI 90	Figure 53	63

INSTALLATION MANUAL

FIRE SEALING IN CLT CONSTRUCTIONS

Fire Stopping System Hand Book

FIRESAFE

Date: 19.11.2021

Prepared by: Pål Paulsen

Controlled by: Hallvard K Engøy

Rev.: 01

TYPE OF INSTALLATION AND FIRE STOPPING PRODUCT	FIRE RESISTANCE	DETAILS	PAGE
Product: FIRESAFE FIRE WRAP			64
Cast iron pipe (d) ≤ Ø 110 mm, (t) 3.5 mm. 13 mm Armaflex AF. C/U. CLT wall ≥ 100 mm.	E 90 – EI 60	Figure 54	65
Cast iron pipe (d) ≤ Ø 110 mm, (t) 3.5 mm. 13 mm Armaflex AF. C/U. CLT floor slab ≥ 140 mm.	E 90 – EI 60	Figure 55	66
Cast iron pipe (d) ≤ Ø 58 mm, (t) 3.5 mm. Pipe insulation 13 mm Armaflex AF. C/U. CLT floor slab ≥ 140 mm.	E 90 – EI 90	Figure 56	67
PE plastic pipe (d) ≤ Ø 110 mm, (t) 3.4 mm. U/C. CLT wall ≥ 100 mm.	E 90 – EI 30	Figure 57	68
PE plastic pipe (d) ≤ Ø 110 mm, (t) 3.4 mm. U/C. CLT floor slab ≥ 140 mm.	E 90 – EI 90	Figure 58	69
PE plastic pipe (d) ≤ Ø 110 mm, (t) 10 mm. U/C. CLT wall ≥ 100 mm.	E 90 – EI 30	Figure 59	70
PE plastic pipe (d) ≤ Ø 110 mm, (t) 10 mm. U/C. CLT floor slab ≥ 140 mm.	E 90 – EI 90	Figure 60	71
PP plastic pipe (d) ≤ Ø 110 mm, (t) 2.7 mm. U/C. CLT wall ≥ 100 mm.	E 90 – EI 60	Figure 61	72
PP plastic pipe (d) ≤ Ø 110 mm, (t) 2.7 mm. U/C. CLT floor slab ≥ 140 mm.	E 90 – EI 90	Figure 62	73
PP plastic pipe (d) ≤ Ø 110 mm, (t) 6.3 mm. U/C. CLT wall ≥ 100 mm.	E 90 – EI 90	Figure 63	74
PP plastic pipe (d) ≤ Ø 110 mm, (t) 6.3 mm. U/C. CLT floor slab ≥ 140 mm.	E 90 – EI 90	Figure 64	75
Aluminium pipe type alu PE-X (d) ≤ Ø 16 mm, (t) 2.25 mm. 13 mm Armaflex AF. U/C CLT floor slab ≥ 140 mm.	E 90 – EI 90	Figure 65	76
Aluminium pipe type alu PE-X (d) ≤ Ø 63 mm, (t) 4.5 mm. 13 mm Armaflex AF. U/C CLT floor slab ≥ 140 mm.	E 90 – EI 90	Figure 66	77
Steel pipe (d) ≤ Ø 42 mm, (t) 2.6 mm. 13 mm Armaflex AF. C/U CLT floor slab ≥ 140 mm.	E 90 – EI 90	Figure 67	78
Steel pipe (d) ≤ Ø 89.9 mm, (t) 3.0 mm. Pipe insulation 13 mm Armaflex AF. C/U CLT floor slab ≥ 140 mm.	E 90 – EI 90	Figure 68	79
Copper pipe and steel pipe (d) ≤ Ø 12 mm, (t) 1.0 mm. Pipe insulation 13 mm Armaflex AF. C/U CLT floor slab ≥ 140 mm.	E 90 – EI 90	Figure 69	80
Copper pipe and steel pipe (d) ≤ Ø 76.1 mm, (t) 2.0 mm. Pipe insulation 13 mm Armaflex AF. C/U CLT floor slab ≥ 140 mm.	E 90 – EI 30	Figure 70	81

INSTALLATION MANUAL

FIRE SEALING IN CLT CONSTRUCTIONS

Fire Stopping System Hand Book

FIRESAFE

Date: 19.11.2021

Prepared by: Pål Paulsen

Controlled by: Hallvard K Engøy

Rev.: 01

TYPE OF INSTALLATION AND FIRE STOPPING PRODUCT	FIRE RESISTANCE	DETAILS	PAGE
Product: FIRESAFE FIRE COLLAR			82
PE plastic pipe (d) ≤ Ø 110 mm, (t) 3.4 mm. U/C. CLT wall ≥ 100 mm.	E 90 – EI 90	Figure 71	83
PE plastic pipe (d) ≤ Ø 110 mm, (t) 3.4 mm. U/C. CLT floor slab ≥ 140 mm.	E 90 – EI 90	Figure 72	84
PE plastic pipe (d) ≤ Ø 110 mm, (t) 10 mm. U/C. CLT wall ≥ 100 mm.	E 90 – EI 60	Figure 73	85
PE plastic pipe (d) ≤ Ø 110 mm, (t) 10 mm. U/C. CLT floor slab ≥ 140 mm.	E 90 – EI 90	Figure 74	86
PP plastic pipe (d) ≤ Ø 110 mm, (t) 2.7 mm. U/C. CLT wall ≥ 100 mm.	E 90 – EI 90	Figure 75	87
PP plastic pipe (d) ≤ Ø 110 mm, (t) 2.7 mm. U/C. CLT floor slab ≥ 140 mm.	E 90 – EI 90	Figure 76	88
PP plastic pipe (d) ≤ Ø 110 mm, (t) 6.3 mm. U/C. CLT wall ≥ 100 mm.	E 60 – EI 30	Figure 77	89
PP plastic pipe (d) ≤ Ø 110 mm, (t) 6.3 mm. U/C. CLT floor slab ≥ 140 mm.	E 90 – EI 90	Figure 78	90
PP-MD plastic pipe (d) ≤ Ø 110 mm, (t) 3.8 mm. U/C. With 90° bend. CLT floor slab ≥ 100 mm.	E 90 – EI 90	Figure 79	91
Aluminium pipe type alu PE-X (d) ≤ Ø 16 mm, (t) 2.25 mm. 13 mm Armaflex AF. U/C CLT floor slab ≥ 140 mm.	E 90 – EI 90	Figure 80	92

TYPE OF INSTALLATION AND FIRE STOPPING PRODUCT	FIRE RESISTANCE	DETAILS	PAGE
Product: FIRESAFE WRAP LX			93
PP plastic pipe (d) ≤ Ø 110 mm, (t) 6.3 mm. U/C. CLT floor slab ≥ 140 mm.	E 90 – EI 90	Figure 81	94

TYPE OF INSTALLATION AND FIRE STOPPING PRODUCT	FIRE RESISTANCE	DETAILS	PAGE
Product: FIRESAFE EX HEAT-EXPANDING SEALANT			95
PP plastic pipe (d) ≤ Ø 110 mm, (t) 6.3 mm. U/C. CLT floor slab ≥ 140 mm.	E 90 – EI 90	Figure 82	96

FIRESAFE KL reserve

PRODUCT DESCRIPTION

FIRESAFE KL-reserve is a system that enables subsequent pulling of new cables.

FIRESAFE KL-reserve has an external diameter of \varnothing 32 mm or \varnothing 50 mm and is available in multiple lengths.

FIRESAFE KL-reserve consists of PVC-U plastic in accordance with EN 61386-21. Closed inside with a 25 mm thick cold smoke seal of mineral wool with fire retardant paint.

FIRESAFE KL-reserve has an external coating at each end with a heat-expanding laminate. The heat-expanding laminate expands at a temperature of approx. 190 °C, to 20 times its original volume and quickly closes penetrations (with or without cable) in the event of fire.

AREAS OF USE

- FIRESAFE KL-reserve can be used with all types of electrical cables and telecommunications cables with a diameter of \leq 21 mm.
- FIRESAFE KL-reserve can be filled with multiple cables, provided there is room for smoke sealing inside the conduit, or can be left empty (without a cable).

CERTIFICATION / FIRE RESISTANCE

- FIRESAFE KL-reserve has been tested in accordance with NS-EN 1366-3 (2009) and EN 13501-1/2.
- Certified in accordance with ETA 15/0026 for FIRESAFE GPG MORTAR.
- Norwegian product documentation issued by RISE Fire Research AS: RISEFR AA-050 and RISEFR 030-0307.
- Fire resistance class EI 90 in CLT structures (cross-laminated timber structures).
- Fire-rated walls in accordance with EN 1363-1. Plaster or masonry walls/precast structure (density 600–650 kg/m³) \geq 100 mm.
- Fire-rated floor slabs in accordance with EN 1363-1. Floor slabs of masonry/precast structure (density 600–650 kg/m³) \geq 150 mm.
- Fire resistance class EI 180 – EI 240 plaster and masonry structures/precast structure in combination with FIRESAFE GPG MORTAR.
- For more details, see installation instructions for FIRESAFE GPG MORTAR at www.firesafe.no.

INSTALLATION

The opening between KL-reserve and CLT wall/floor is made smoke and fireproof with FIRESAFE FT Acrylic.

When installing multiple penetrations with KL-reserve, there must be a minimum distance of 15 mm between the conduits.

See subsequent pages in the installation instructions.

SUPPLIED AS

Supplied as individual pcs or in cartons.

Article No./ SIZE D x L / NUMBER OF FIRESAFE KL-RESERVE PER CARTON

- FS – Article no.: 102026. KL-reserve \varnothing 32 x 130 mm. 154 pcs per carton.
- FS – Article no.: 102027. KL-reserve \varnothing 50 x 130 mm. 70 pcs per carton.
- FS – Article no.: 102020. KL-reserve \varnothing 32 x 150 mm. 154 pcs per carton.
- FS – Article no.: 102021. KL-reserve \varnothing 32 x 200 mm. 126 pcs per carton.
- FS – Article no.: 102022. KL-reserve \varnothing 32 x 300 mm. 77 pcs per carton.
- FS – Article no.: 102023. KL-reserve \varnothing 50 x 150 mm. 70 pcs per carton.
- FS – Article no.: 102024. KL-reserve \varnothing 50 x 200 mm. 60 pcs per carton.
- FS – Article no.: 102025. KL-reserve \varnothing 50 x 300 mm. 35 pcs per carton.

SAFETY FACTORS

- There are no health risks or safety issues associated with the product. See separate material safety data sheet for FIRESAFE KL-reserve.



INSTALLATION MANUAL

FIRE SEALING IN CLT CONSTRUCTIONS

Fire Stopping System Hand Book

FIRESAFE /

Date: 19.11.2021

Prepared by: Pål Paulsen

Controlled by: Hallvard K Engøy

Rev.: 01

Table 1: CLT wall ≥ 100 mm.		
KL-reserve (PVC cable conduit) (d).	Fire resistance class	See detail, figure:
FIRESAFE KL-reserve PVC cable conduit $\varnothing 32$ mm. Max cable (d) $\leq \varnothing 21$ mm. Opening in wall d: $\varnothing 42$ – 50 mm. Double-sided smoke sealing with FIRESAFE FT Acrylic.	E 90 – EI 90	Figure 1
FIRESAFE KL-reserve PVC cable conduit $\varnothing 50$ mm. Max cable (d) ≤ 2 pcs $\varnothing 21$ mm. Opening in wall d: $\varnothing 60$ – 64 mm. Double-sided smoke sealing with FIRESAFE FT Acrylic.	E 90 – EI 90	

Installation, Figure 1

- Drill holes in the CLT wall, adapted to the diameter of the KL-reserve conduit, including space for smoke sealing and fire sealing with FIRESAFE FT Acrylic.
- When installing multiple KL-reserve conduits, there must be a minimum distance of 15 mm between each individual cable conduit.
- Remove any debris and dust from the opening.
- Moisten absorbent materials with water or primer.
- Use FIRESAFE FT Acrylic to seal the opening between the CLT wall and the KL-reserve conduit against smoke and fire.

Note: Apply FIRESAFE FT Acrylic as a smoke seal around the KL-reserve conduit on both sides of the wall. Sealant width, 3–5 mm.



FIRESAFE /

All information in this data sheet is to be regarded as normative values obtained from tests and our collective knowledge and experience of the product. This data must not be used as a basis for or verification of other tests or systems. Firesafe AS accepts no liability for other use or misuse of the product. Users are responsible for ensuring they use the latest version of this document. Please check our website www.firesafe.no. This document may not be copied without the written consent of Firesafe AS.

Table 2: CLT floor slab ≥ 140 mm.		
KL-reserve (PVC cable conduit) (d).	Fire resistance class	See detail, figure:
FIRESAFE KL-reserve PVC cable conduit $\varnothing 32$ mm. Max cable (d) $\leq \varnothing 21$ mm. Opening in wall d: $\varnothing 42$ – 50 mm. Double-sided smoke sealing with FIRESAFE FT Acrylic.	E 90 – EI 90	Figure 2
FIRESAFE KL-reserve PVC cable conduit $\varnothing 50$ mm. Max cable (d) ≤ 2 pcs $\varnothing 21$ mm. Opening in wall d: $\varnothing 60$ – 64 mm. Double-sided smoke sealing with FIRESAFE FT Acrylic.	E 90 – EI 90	

Installation, Figure 2

- Drill holes in the CLT floor slab, adapted to the diameter of the KL-reserve conduit, including space for smoke and fire sealing with FIRESAFE FT Acrylic.
- When installing multiple KL-reserve conduits, there must be a minimum distance of 15 mm between each individual cable conduit.
- Remove any debris and dust from the opening.
- Moisten absorbent materials with water or primer.
- Use FIRESAFE FT Acrylic to seal the opening between the CLT floor slab and the KL-reserve conduit against smoke.

Note: Apply FIRESAFE FT Acrylic as a smoke seal around the KL-reserve conduit on both sides of the floor slab. Sealant width, 3–5 mm.



INSTALLATION MANUAL

FIRE SEALING IN CLT CONSTRUCTIONS

Fire Stopping System Hand Book

FIRESAFE

Date: 19.11.2021

Prepared by: Pål Paulsen

Controlled by: Hallvard K Engøp

Rev.: 01

FIRESAFE FT ACRYLIC

PRODUCT DESCRIPTION

Firesafe FT Acrylic is a heat-expanding, single-component acrylic-based joint sealant.

FIRESAFE FT Acrylic expands to twice its original volume at a temperature of approx. 180 °C.

AREAS OF USE

Fireproof sealing of large joints and openings; penetration sealing of individual cables and cable bundles. Stand-alone plastic electrical cable conduits and stand-alone PVC plastic pipes.

Sealing penetrations for alu PE-X aluminium pipes, insulated copper/steel and cast iron pipes.

See the separate installation instructions for FIRESAFE FT Acrylic for details.

The sealant can also be used for large openings in combination with FIRESAFE FT Board in brick/concrete or plasterboard constructions. See the installation instructions for FT Board for details.

CERTIFICATION / FIRE RESISTANCE / ARTICLE NO. / EL NO.

- FIRESAFE FT Acrylic has been tested in accordance with NS-EN 1366-3 (2009) and NS-EN 1366-4 (2009), as well as EN 13501-1/2.
- Certified in accordance with ETA 16/0094 – 16/0102.
- Fire resistance EI 30 to EI 240 with extensive areas of application for walls and floors.

FIRE-CLASSIFIED WALLS AND FLOOR SLABS IN ACCORDANCE WITH EN 1363-1.:

- Plaster or masonry walls/precast structure (density 600–650 kg/m³) ≥ 100 mm.
- Floor slabs of masonry/precast structure (density 600–650 kg/m³) ≥ 150 mm.
- Fire resistance class EI 90 in CLT structures (cross-laminated timber structures).
- Approved as a smoke seal in accordance with EN 1634-3.
- For more information, see the DoP on www.firesafe.no.
- FIRESAFE Article no.: 100 045

APPLICATION

- Ensure that any openings to be sealed with Firesafe FT Acrylic are free from dust and grease.
- Treat absorbent materials with water or primer first.
- Push infill into the opening where necessary. You can use infill of mineral wool, ceramic fibre, or a PE strip or no infill.
- Apply the sealant in the opening and ensure good adhesion to all surfaces.
- Smooth the sealant over the opening. If neat edges are desired, use masking tape.
- The sealant can normally be painted over after 24 hours, but always check adhesion.
- Firesafe FT Acrylic must not be applied at temperatures lower than +5 °C.
- Penetration sealing or joint sealing is carried out using a sealant gun and standard jointing tools.
- Tools should be cleaned with water.

PACKAGING

- Plastic cartridge for standard sealant gun: contents 310 ml.
- Supplied in boxes of 25 cartridges.

STORAGE/SHELF LIFE

- Store in a dry place, between +5 °C and +30 °C. Best stored in a cool and dark place.
- Shelf life: at least 12 months in unopened packaging.
- Must be protected from frost.

SAFETY

- The sealant is solvent free and environmentally friendly. Not known to be an irritant in the event of contact with skin, but avoid contact with eyes or mouth. See separate material safety data sheet for FIRESAFE FT Acrylic.



Colour: White and RAL 9015 (wood colour)
Application temp.: +5 °C to + 30 °C
Drying time (appearance): 15 mins.
Drying time (hardened): 1–24 hours
Flexibility: 12%.
Expansion: 1: 2
Storage temperature: +15 °C to + 30 °C.

Table 3: CLT wall ≥ 100 mm.		
Corrugated electrical cable conduit of PVC-U plastic. (d) $\leq \varnothing 32$ mm. C/C.	Fire resistance class	See detail, figure:
Corrugated electrical cable conduit of PVC-U plastic. (d) $\leq \varnothing 32$ mm. Max cable (d) $\varnothing 21$ mm. C/C. Opening in wall d: $\varnothing 52$ mm. Double-sided Fire Stopping with FIRESAFE FT Acrylic.	E 90 – EI 60	Figure 3

Installation, Figure 3

- Remove any debris and dust from the opening.
- Moisten absorbent materials with water or primer.
- Seal the opening between the electrical cable conduit and the CLT with FIRESAFE FT Acrylic at a width of 10 mm and a depth of 25 mm.

Note: Apply FIRESAFE FT Acrylic around the electrical cable conduit, flush with the wall on both sides. Width 10 mm x 25 mm depth.

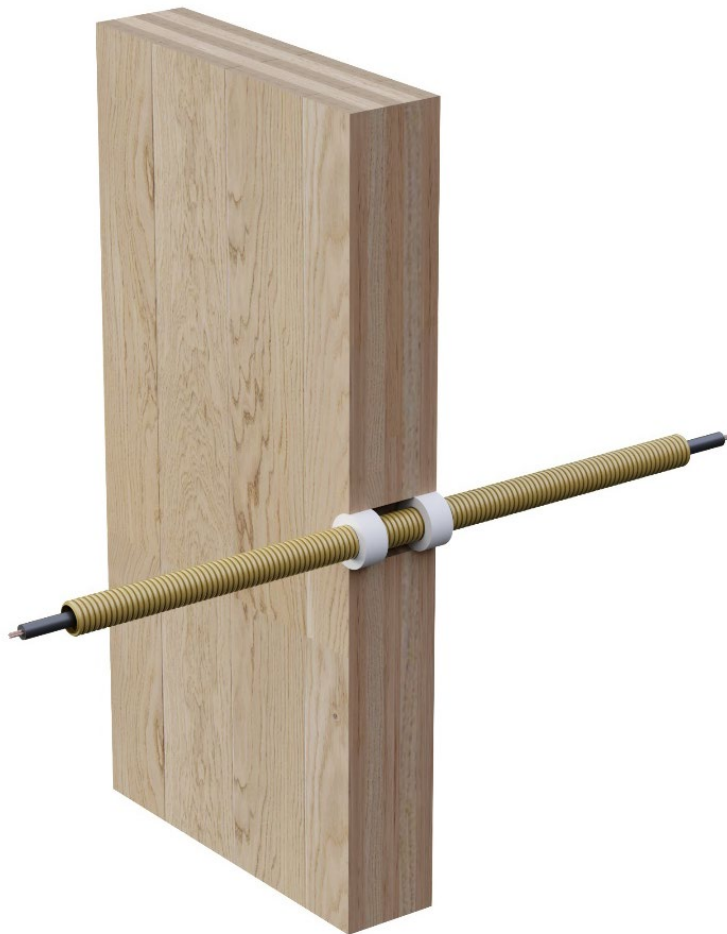

Schematic diagram.



Table 4: CLT floor slab ≥ 140 mm.		
Corrugated electrical cable conduit of PVC-U plastic. (d) $\leq \varnothing 32$ mm. C/C.	Fire resistance class	See detail, figure:
Corrugated electrical cable conduit of PVC-U plastic. (d) $\leq \varnothing 32$ mm. Max cable (d) $\varnothing 21$ mm. C/C. Opening in floor slab d: $\varnothing 52$ mm. Double-sided fire sealing with FIRESAFE FT Acrylic.	E 90 – EI 90	Figure 4

Installation, Figure 4

- Remove any debris and dust from the opening.
- Moisten absorbent materials with water or primer.
- Seal the opening between the electrical cable conduit and the CLT with FIRESAFE FT Acrylic at a width of 10 mm and a depth of 25 mm.

Note: Apply FIRESAFE FT Acrylic around the electrical cable conduit, flush with the floor slab on both sides. Width 10 mm x 25 mm depth.



Schematic diagram.



Table 5: CLT wall ≥ 100 mm.		
Smooth electrical cable conduit of PVC-U plastic. (d) $\leq \varnothing 32$ mm. C/C.	Fire resistance class	See detail, figure:
Smooth electrical cable conduit of PVC-U plastic. (d) $\leq \varnothing 32$ mm. Max cable (d) $\varnothing 21$ mm. C/C. Opening in wall d: $\varnothing 52$ mm. Double-sided fire sealing with FIRESAFE FT Acrylic.	E 90 – EI 90	Figure 5

Installation, Figure 5

- Remove any debris and dust from the opening.
- Moisten absorbent materials with water or primer.
- Seal the opening between the electrical cable conduit and the CLT with FIRESAFE FT Acrylic at a width of 10 mm and a depth of 25 mm.

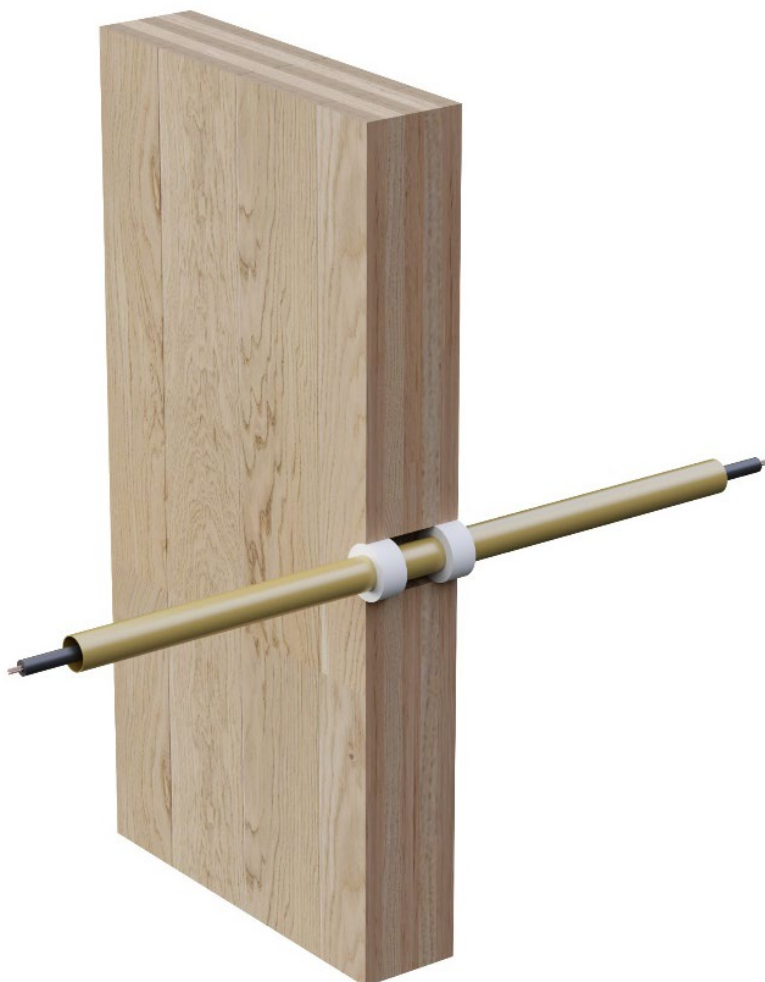

Note: Apply FIRESAFE FT Acrylic around the electrical cable conduit, flush with the wall on both sides. Width 10 mm x 25 mm depth.



Schematic diagram.



INSTALLATION MANUAL

FIRE SEALING IN CLT CONSTRUCTIONS

Fire Stopping System Hand Book

FIRESAFE /

Date: 19.11.2021

Prepared by: Pål Paulsen

Controlled by: Hallvard K Engøy

Rev.: 01

Table 6: CLT floor slab ≥ 140 mm.		
Smooth electrical cable conduit of PVC-U plastic. (d) $\leq \varnothing 32$ mm. C/C.	Fire resistance class	See detail, figure:
Smooth electrical cable conduit of PVC-U plastic. (d) $\leq \varnothing 32$ mm. Max cable (d) $\varnothing 21$ mm. C/C. Opening in floor slab d: $\varnothing 52$ mm. Double-sided fire sealing with FIRESAFE FT Acrylic.	E 90 – EI 90	Figure 6

Installation, Figure 6

- Remove any debris and dust from the opening.
- Moisten absorbent materials with water or primer.
- Seal the opening between the electrical cable conduit and the CLT with FIRESAFE FT Acrylic at a width of 10 mm and a depth of 25 mm.



Note: Apply FIRESAFE FT Acrylic around the electrical cable conduit, flush with the floor slab on both sides. Width 10 mm x 25 mm depth.



Schematic diagram.



FIRESAFE /

All information in this data sheet is to be regarded as normative values obtained from tests and our collective knowledge and experience of the product. This data must not be used as a basis for or verification of other tests or systems. Firesafe AS accepts no liability for other use or misuse of the product. Users are responsible for ensuring they use the latest version of this document. Please check our website www.firesafe.no. This document may not be copied without the written consent of Firesafe AS.

Table 7: CLT wall ≥ 100 mm.		
Cable bundle (d) $\leq \varnothing 90$ mm, cable (d) $\leq \varnothing 21$ mm.	Fire resistance class	See detail, figure:
Cable bundle (d) $\leq \varnothing 90$ mm, cable (d) $\leq \varnothing 21$ mm. Opening in wall d: $\varnothing 110$ mm. Double-sided fire sealing with FIRESAFE FT Acrylic.	E 90 – EI 90	Figure 7

Installation, Figure 7

- Remove any debris and dust from the opening.
- Moisten absorbent materials with water or primer.
- Seal the opening around the cable bundle in the CLT with FIRESAFE FT Acrylic at a width of 10 mm and a depth of 25 mm.



Note: Apply FIRESAFE FT Acrylic around the cable bundle, flush with the wall on both sides. Width 10 mm x 25 mm depth. Apply a small amount of FT Acrylic between the cables as a smoke seal.



Schematic diagram.



INSTALLATION MANUAL

FIRE SEALING IN CLT CONSTRUCTIONS

Fire Stopping System Hand Book

FIRESAFE /

Date: 19.11.2021

Prepared by: Pål Paulsen

Controlled by: Hallvard K Engøy

Rev.: 01

Table 8: CLT floor slab ≥ 140 mm.		
Cable bundle (d) $\leq \varnothing 90$ mm, cable (d) $\leq \varnothing 21$ mm.	Fire resistance class	See detail, figure:
Cable bundle (d) $\leq \varnothing 90$ mm, cable (d) $\leq \varnothing 21$ mm. Opening in floor slab d: $\varnothing 110$ mm. Double-sided fire sealing with FIRESAFE FT Acrylic.	E 90 – EI 90	Figure 8

Installation, Figure 8

- Remove any debris and dust from the opening.
- Moisten absorbent materials with water or primer.
- Seal the opening around the cable bundle in the CLT with FIRESAFE FT Acrylic at a width of 10 mm and a depth of 25 mm.



Note: Apply FIRESAFE FT Acrylic around the cable bundle, flush with the floor slab on both sides. Width 10 mm x 25 mm depth. Apply a small amount of FT Acrylic between the cables as a smoke seal.



Schematic diagram.



FIRESAFE /

All information in this data sheet is to be regarded as normative values obtained from tests and our collective knowledge and experience of the product. This data must not be used as a basis for or verification of other tests or systems. Firesafe AS accepts no liability for other use or misuse of the product. Users are responsible for ensuring they use the latest version of this document. Please check our website www.firesafe.no. This document may not be copied without the written consent of Firesafe AS.

INSTALLATION MANUAL

FIRE SEALING IN CLT CONSTRUCTIONS

Fire Stopping System Hand Book

FIRESAFE /

Date: 19.11.2021

Prepared by: Pål Paulsen

Controlled by: Hallvard K Engøy

Rev.: 01

Table 9: CLT wall ≥ 100 mm.		
Plastic pipe type: pipe-in-pipe type PE-X (d) OD $\leq \varnothing 25$ mm ID $\leq \varnothing 16$ mm. C/C.	Fire resistance class	See detail, figure:
pipe-in-pipe type PE-X (d) OD $\leq \varnothing 25$ mm ID $\leq \varnothing 16$ mm. C/C. Opening in wall d: $\varnothing 45$ mm. Double-sided fire sealing with FIRESAFE FT Acrylic.	E 90 – EI 90	Figure 9

Installation, Figure 9

- Remove any debris and dust from the opening.
- Moisten absorbent materials with water or primer.
- Seal the opening around the pipe in the CLT with FIRESAFE FT Acrylic at a width of 10 mm and a depth of 25 mm.

Note: Apply FIRESAFE FT Acrylic around the pipe, flush with the wall on both sides. Width 10 mm x 25 mm depth.



Schematic diagram.



FIRESAFE /

All information in this data sheet is to be regarded as normative values obtained from tests and our collective knowledge and experience of the product. This data must not be used as a basis for or verification of other tests or systems. Firesafe AS accepts no liability for other use or misuse of the product. Users are responsible for ensuring they use the latest version of this document. Please check our website www.firesafe.no. This document may not be copied without the written consent of Firesafe AS.

INSTALLATION MANUAL

FIRE SEALING IN CLT CONSTRUCTIONS

Fire Stopping System Hand Book

FIRESAFE /

Date: 19.11.2021

Prepared by: Pål Paulsen

Controlled by: Hallvard K Engøy

Rev.: 01

Table 10: CLT floor slab ≥ 140 mm.		
Plastic pipe type: pipe-in-pipe type PE-X (d) OD $\leq \varnothing 25$ mm ID $\leq \varnothing 16$ mm. C/C.	Fire resistance class	See detail, figure:
pipe-in-pipe type PE-X (d) OD $\leq \varnothing 25$ mm ID $\leq \varnothing 16$ mm. C/C. Opening in floor slab d: $\varnothing 45$ mm. Double-sided fire sealing with FIRESAFE FT Acrylic.	E 90 – EI 90	Figure 10

Installation, Figure 10

- Remove any debris and dust from the opening.
- Moisten absorbent materials with water or primer.
- Seal the opening around the pipe in the CLT with FIRESAFE FT Acrylic at a width of 10 mm and a depth of 25 mm.



Note: Apply FIRESAFE FT Acrylic around the pipe, flush with the floor slab on both sides. Width 10 mm x 25 mm depth.



Schematic diagram.



FIRESAFE /

All information in this data sheet is to be regarded as normative values obtained from tests and our collective knowledge and experience of the product. This data must not be used as a basis for or verification of other tests or systems. Firesafe AS accepts no liability for other use or misuse of the product. Users are responsible for ensuring they use the latest version of this document. Please check our website www.firesafe.no. This document may not be copied without the written consent of Firesafe AS.

Table 11: CLT wall ≥ 100 mm.		
Aluminium pipe type alu PE-X (d) $\leq \varnothing 25$ mm. C/C.	Fire resistance class	See detail, figure:
Alu PE-X (d) $\leq \varnothing 25$ mm, (t) 2.25 mm. 13 mm Armaflex AF. C/C. Opening in wall d: $\varnothing 71$ mm. Double-sided fire sealing with FIRESAFE FT Acrylic.	E 90 – EI 90	Figure 11

Installation, Figure 11

- Remove any debris and dust from the opening.
- Moisten absorbent materials with water or primer.
- Seal the opening around the insulated pipe in the CLT with FIRESAFE FT Acrylic at a width of 10 mm and a depth of 25 mm.

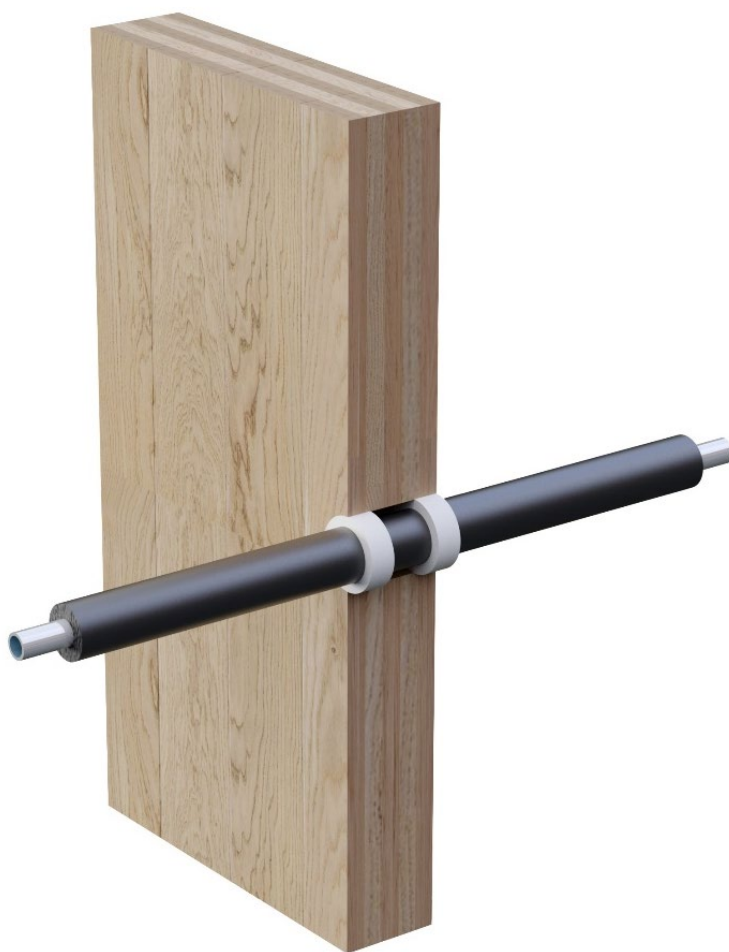

Note: Apply FIRESAFE FT Acrylic around the pipe, flush with the wall on both sides. Width 10 mm x 25 mm depth.



Schematic diagram.



*Pipes insulated with 13 mm cellular rubber of type Armaflex AF. Fire rating, Euroclass B/BL, s3-d0.

LS: Continuous pipe insulation, 13 mm thick, with 700 mm extending out on each side of the wall.

CS: The specified insulation must run the entire length of the pipe or a minimum of 1,500 mm, including in the penetration itself.

Table 12: CLT wall ≥ 100 mm.		
Cast iron pipe (d) $\leq \varnothing 58$ mm. C/U.	Fire resistance class	See detail, figure:
Cast iron pipe (d) $\leq \varnothing 58$ mm, (t) 3.5 mm. 20 mm PAROC Hvac Section AluCoat T. C/U. Opening in wall d: $\varnothing 68$ mm. Double-sided fire sealing with FIRESAFE FT Acrylic.	E 90 – EI 90	Figure 12

Installation, Figure 12

- Remove any debris and dust from the opening.
- Moisten absorbent materials with water or primer.
- Seal the opening around the pipe in the CLT with FIRESAFE FT Acrylic at a width of 5 mm and a depth of 25 mm.
- Apply pipe insulation after the pipe has been sealed with FIRESAFE FT Acrylic.

Note: Apply FIRESAFE FT Acrylic around the pipe, flush with the wall on both sides. Width 5 mm x 25 mm depth.

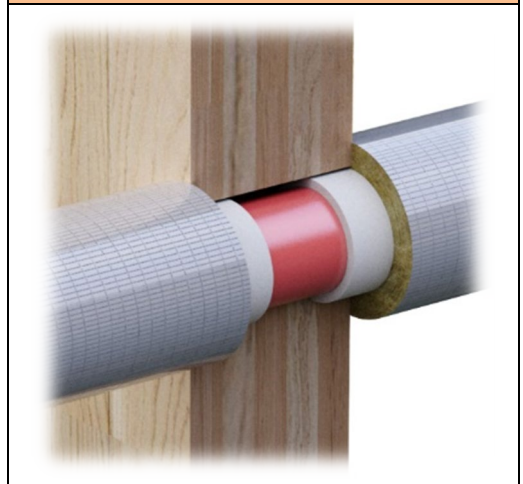
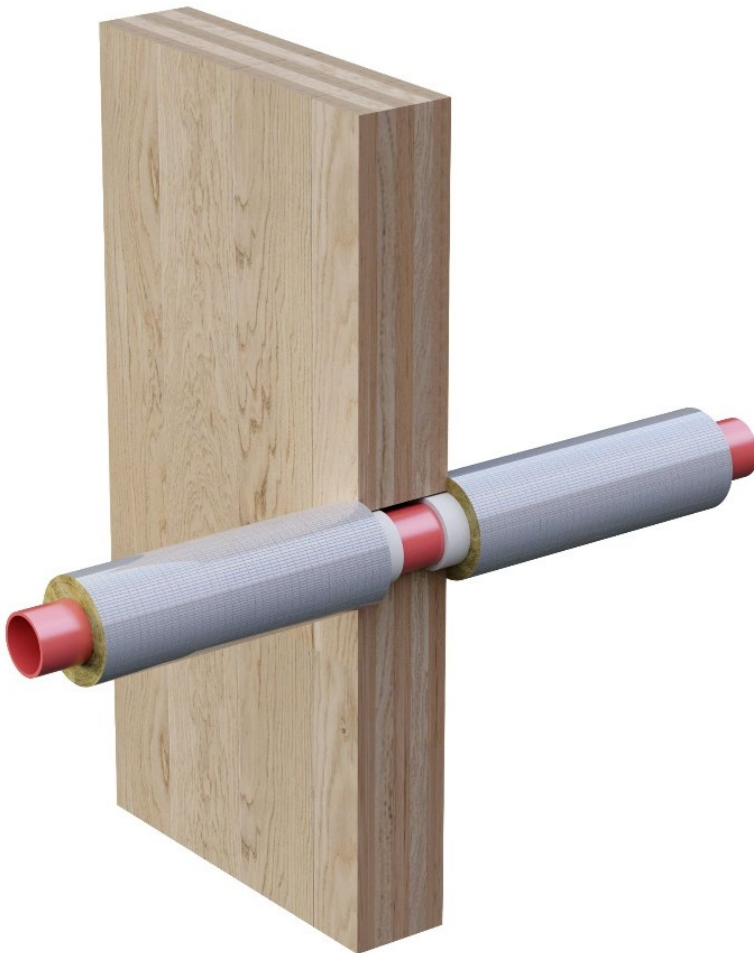

Schematic diagram.



*Pipe insulation type PAROC Hvac Section AluCoat T of mineral wool, density 85 kg/m³. Fire rating A2-s1, d0.
Or mineral wool pipe insulation with the same density, thickness and fire rating

LI: Specified insulation locally with specified length from the wall on both sides (minimum 600 mm), excluding the penetration itself.

CI: The specified insulation must run the entire length of the pipe excluding the penetration itself, minimum 600 mm on each side of the penetration.

Table 13: CLT floor slab ≥ 140 mm.		
Cast iron pipe (d) $\leq \varnothing 58$ mm. C/U.	Fire resistance class	See detail, figure:
Cast iron pipe (d) $\leq \varnothing 58$ mm, (t) 3.5 mm. 20 mm PAROC Hvac Section AluCoat T. C/U. Opening in floor slab d: $\varnothing 68$ mm. Double-sided fire sealing with FIRESAFE FT Acrylic.	E 90 – EI 90	Figure 13

Installation, Figure 13

- Remove any debris and dust from the opening.
- Moisten absorbent materials with water or primer.
- Seal the opening around the pipe in the CLT with FIRESAFE FT Acrylic at a width of 5 mm and a depth of 25 mm.
- Apply pipe insulation after the pipe has been sealed with FIRESAFE FT Acrylic.

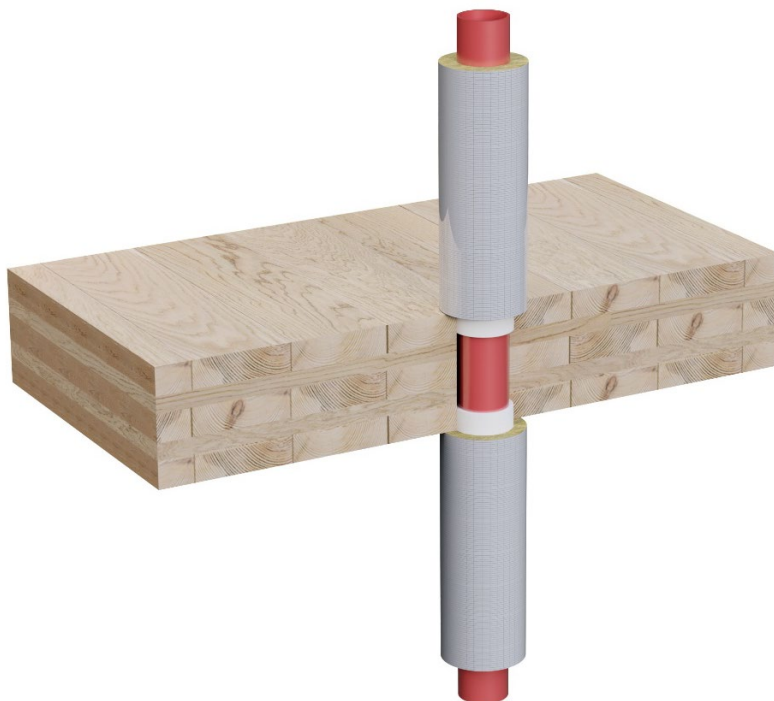

Note: Apply FIRESAFE FT Acrylic around the pipe, flush with the floor slab on both sides. Width 5 mm x 25 mm depth.

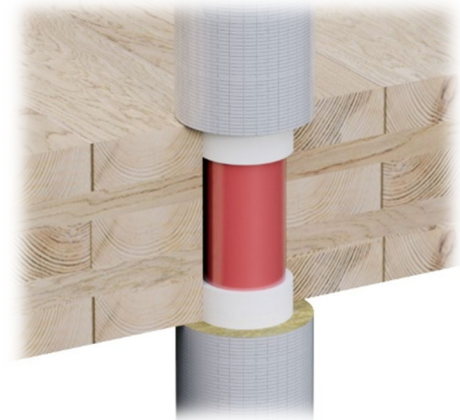

Schematic diagram.



*Pipe insulation type PAROC Hvac Section AluCoat T of mineral wool, density 85 kg/m^3 . Thickness 20 mm. Fire rating A2 -s1, d0 .
Or mineral wool pipe insulation with the same density, thickness and fire rating

LI: Specified insulation locally with specified length from the wall on both sides (minimum 600 mm), excluding the penetration itself.

CI: The specified insulation must run the entire length of the pipe excluding the penetration itself, minimum 600 mm on each side of the penetration.

Table 14: CLT wall ≥ 100 mm.		
Cast iron pipe (d) $\leq \varnothing 110$ mm. C/U.	Fire resistance class	See detail, figure:
Cast iron pipe (d) $\leq \varnothing 110$ mm, (t) 3.5 mm. 30 mm PAROC Hvac Section AluCoat T. C/U. Opening in wall d: $\varnothing 120$ mm. Double-sided fire sealing with FIRESAFE FT Acrylic.	E 90 – EI 90	Figure 14

Installation, Figure 14

- Remove any debris and dust from the opening.
- Moisten absorbent materials with water or primer.
- Seal the opening around the pipe in the CLT with FIRESAFE FT Acrylic at a width of 5 mm and a depth of 25 mm.
- Apply pipe insulation after the pipe has been sealed with FIRESAFE FT Acrylic.

Note: Apply FIRESAFE FT Acrylic around the pipe, flush with the wall on both sides. Width 5 mm x 25 mm depth.

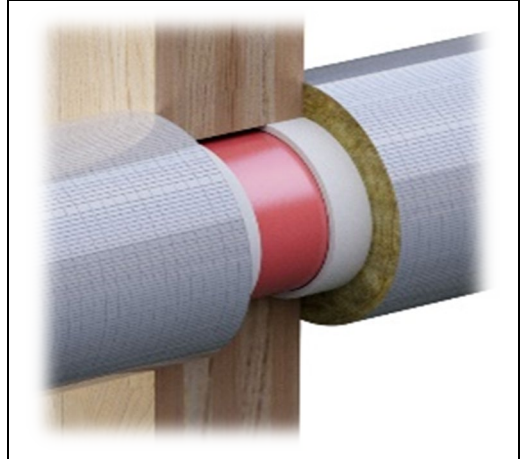
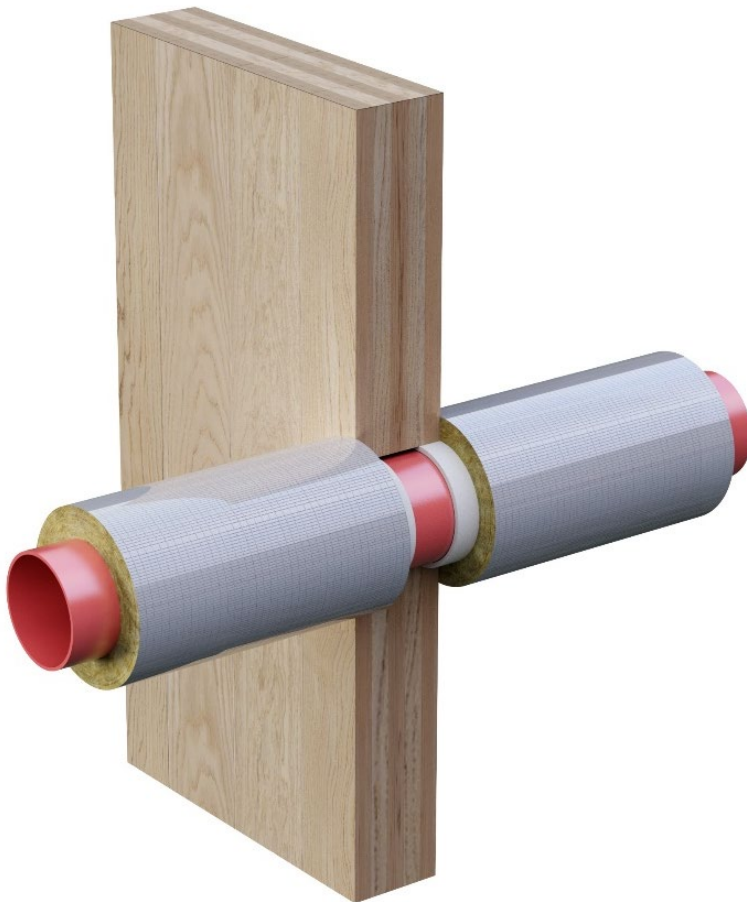

Schematic diagram.



*Pipe insulation type PAROC Hvac Section AluCoat T of mineral wool, density 85 kg/m³. Thickness 30 mm. Fire rating A2 _{s1}-s1, d0.
Or mineral wool pipe insulation with the same density, thickness and fire rating

LI: Specified insulation locally with specified length from the wall on both sides (minimum 600 mm), excluding the penetration itself.

CI: The specified insulation must run the entire length of the pipe excluding the penetration itself, minimum 600 mm on each side of the penetration.

Table 15: CLT floor slab ≥ 140 mm.		
Cast iron pipe (d) $\leq \varnothing 110$ mm. C/U.	Fire resistance class	See detail, figure:
Cast iron pipe (d) $\leq \varnothing 110$ mm, (t) 3.5 mm. 30 mm PAROC Hvac Section AluCoat T. C/U. Opening in floor slab d: $\varnothing 120$ mm. Double-sided fire sealing with FIRESAFE FT Acrylic.	E 90 – EI 90	Figure 15

Installation, Figure 15

- Remove any debris and dust from the opening.
- Moisten absorbent materials with water or primer.
- Seal the opening around the pipe in the CLT with FIRESAFE FT Acrylic at a width of 5 mm and a depth of 25 mm.
- Apply pipe insulation after the pipe has been sealed with FIRESAFE FT Acrylic.

Note: Apply FIRESAFE FT Acrylic around the pipe, flush with the floor slab on both sides. Width 5 mm x 25 mm depth.

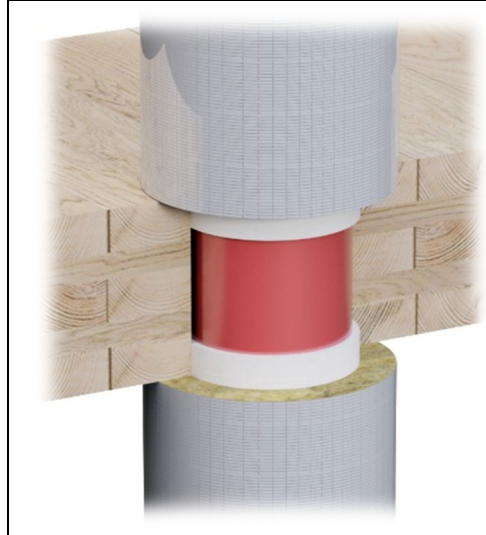
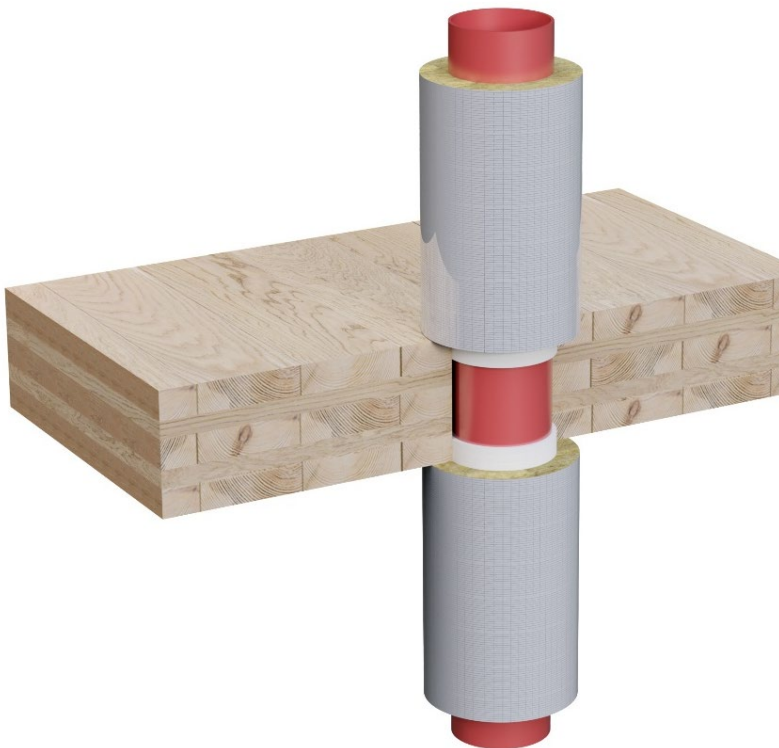

Schematic diagram.



*Pipe insulation type PAROC Hvac Section AluCoat T of mineral wool, density 85 kg/m^3 . Thickness 30 mm. Fire rating A2 L-s1, d0.

Or mineral wool pipe insulation with the same density, thickness and fire rating

LI: Specified insulation locally with specified length from the wall on both sides (minimum 600 mm), excluding the penetration itself.

CI: The specified insulation must run the entire length of the pipe excluding the penetration itself, minimum 600 mm on each side of the penetration.

Table 16: CLT wall ≥ 100 mm.		
Ventilation duct (d) $\leq \varnothing 300$ mm. C/U.	Fire resistance class	See detail, figure:
Ventilation duct (d) $\leq \varnothing 300$ mm, (t) 0.9 mm. 30 mm PAROC Hvac Section Fire Mat. C/U. Opening in wall d: $\varnothing 320$ mm. Double-sided fire sealing with FIRESAFE FT Acrylic.	E 90 – EI 60	Figure 16

Installation, Figure 16

- Remove any debris and dust from the opening.
- Moisten absorbent materials with water or primer.
- Seal the opening around the pipe in the CLT with FIRESAFE FT Acrylic at a width of 10 mm and a depth of 25 mm.
- Apply duct insulation after the duct has been sealed with FIRESAFE FT Acrylic.
- Apply duct insulation with a mesh mat with a 50 mm overlap on longitudinal joints. Stitch all longitudinal and transverse joints with galvanised steel wire or fix the joints with hooks using special pliers. Stitch length and hook distance 50–100 mm.
- Tie round duct insulation around circular ducts with steel wire CC 200 mm.

Note: Apply FIRESAFE FT Acrylic around the duct, flush with the wall on both sides. Width 10 mm x 25 mm depth.



Schematic diagram.



*Duct insulation type PAROC Hvac Fire Mat BlackCoat T of mineral wool, density 90 kg/m³. Thickness 30 mm. Fire rating A2 ℓ -s1, d0.
Or mineral wool pipe insulation with the same density, thickness and fire rating.

LI: Specified insulation locally with specified length from the wall on both sides (minimum 1,200 mm), excluding the penetration itself.

CI: Specified insulation continuous through the entire length of the duct, excluding the penetration itself.

Table 17: CLT floor slab ≥ 140 mm.		
Ventilation duct (d) $\leq \varnothing 300$ mm. C/U.	Fire resistance class	See detail, figure:
Ventilation duct (d) $\leq \varnothing 300$ mm, (t) 0.9 mm. 30 mm PAROC Hvac Section Fire Mat. C/U. Opening in floor slab d: $\varnothing 320$ mm. Double-sided fire sealing with FIRESAFE FT Acrylic.	E 90 – EI 90	Figure 17

Installation, Figure 17

- Remove any debris and dust from the opening.
- Moisten absorbent materials with water or primer.
- Seal the opening around the pipe in the CLT with FIRESAFE FT Acrylic at a width of 10 mm and a depth of 25 mm.
- Apply duct insulation after the duct has been sealed with FIRESAFE FT Acrylic.
- Apply duct insulation with a mesh mat with a 50 mm overlap on longitudinal joints. Stitch all longitudinal and transverse joints with galvanised steel wire or fix the joints with hooks using special pliers. Stitch length and hook distance 50–100 mm.
- Tie round duct insulation around circular ducts with steel wire CC 200 mm.

Note: Apply FIRESAFE FT Acrylic around the duct on both sides of the floor slab. Width 10 mm x 25 mm depth.



Schematic diagram.



*Duct insulation type PAROC Hvac Fire Mat BlackCoat T of mineral wool, density 90 kg/m³. Thickness 30 mm. Fire rating A2 ℓ -s1, d0.
Or mineral wool pipe insulation with the same density, thickness and fire rating

L: Specified insulation locally with specified length from the floor slab on both sides (minimum 1,200 mm), excluding the penetration itself.

CI: Specified insulation continuous through the entire length of the duct, excluding the penetration itself.

Table 18: CLT wall ≥ 100 mm.			
Linear joints. Vertical	Infill, type, density, thickness (mm)	Fire resistance class	See detail, figure
Vertical joint. Joint opening ≤ 20 mm. Double-sided joint with FIRESAFE FT Acrylic.	Mineral wool density 50 kg/m ³ , thickness 80 mm.	E 90 – EI 90	Figure 18

Installation, Figure 18

- Remove any debris and dust from the opening.
- Moisten absorbent materials with water or primer.
- Push mineral wool infill into the opening in the wall. Mineral wool density ≥50 kg/m³, thickness 80 mm.
- Apply FIRESAFE FT Acrylic in the joint opening on both sides of the wall. Width 20 mm x 10 mm depth.

Note: Apply FIRESAFE FT Acrylic in the joint opening on both sides of the wall. Width 20 mm x 10 mm depth.

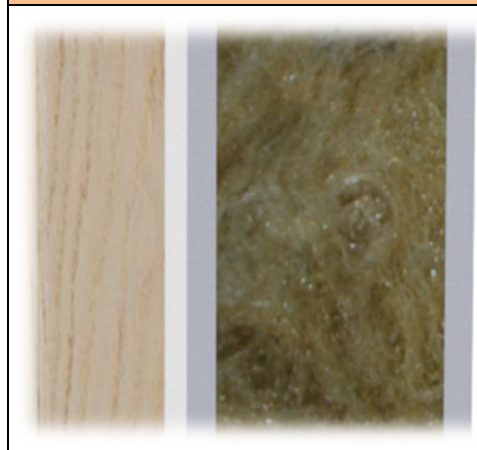

Table 19: CLT wall ≥ 100 mm.			
Linear joints. Horizontal	Infill, type, density, thickness (mm)	Fire resistance class	See detail, figure
Horizontal joint. Joint opening ≤ 20 mm. Double-sided joint with FIRESAFE FT Acrylic.	Mineral wool density 50 kg/m^3 , thickness 80 mm.	E 90 – EI 90	Figure 19

Installation, Figure 19

- Remove any debris and dust from the opening.
- Moisten absorbent materials with water or primer.
- Push mineral wool infill into the opening in the wall. Mineral wool density $\geq 50 \text{ kg/m}^3$, thickness 80 mm.
- Apply FIRESAFE FT Acrylic in the joint opening on both sides of the wall. Width 20 mm x 10 mm depth.

Note: Apply FIRESAFE FT Acrylic in the joint opening on both sides of the wall. Width 20 mm x 10 mm depth.



FIRESAFE FT GRAPHITE

PRODUCT DESCRIPTION

FIRESAFE FT Graphite is a special product suitable for penetration sealing of combustible installations.

FIRESAFE FT Graphite is a heat-expanding, single-component, water-based graphite sealant.

The sealant expands at a temperature as low as approximately 180 °C. The product thus has very good fire protection properties.

AREAS OF USE

- Penetration sealing of metal pipes with combustible and non-combustible pipe insulation.
- Penetration sealing of pipes of type ALUPEX with combustible and non-combustible pipe insulation.
- Penetration sealing of plastic pipes of type PE-Xa with combustible and non-combustible pipe insulation.
- Penetration sealing of plastic electrical cable conduits.
- Penetration sealing of electrical cables.
- Penetration sealing of combustible pipes for heating, ventilation and sanitation.

FIRESAFE FT Graphite is generally used for stand-alone installation work. FIRESAFE FT Graphite in combination with FIRESAFE FT Board or FIRESAFE GPG MORTAR. See also the installation instructions for FIRESAFE FT Board for details.

CERTIFICATION / FIRE RESISTANCE

- FIRESAFE FT Graphite has been tested in accordance with NS-EN 1366-3 (2009) and EN 13501-1/2.
- Certified in accordance with ETA 16/00942.
- Fire resistance EI 30 to EI 240 with extensive areas of application for walls and floors.
- Fire-rated walls in accordance with EN 1366-1.: Plaster or masonry walls/precast structure (density 600–650 kg/m³) ≥100 mm
- Fire-rated floor slabs in accordance with EN 1366-1.: Floor slabs of masonry/precast structure (density 600–650 kg/m³) ≥ 150 mm
- Fire resistance class EI 90 in CLT structures (cross-laminated timber structures).
- Approved as a smoke seal in accordance with EN 1634-3.
- For more information, see the DoP on www.firesafe.no.
- FIRESAFE Article no.: 100 046.

APPLICATION

- Ensure that any openings to be sealed with Firesafe FT Graphite are free from dust and grease.
- Treat absorbent materials with water or primer first.
- Fill the opening with infill material (mineral wool, ceramic fibre or PE board) where necessary.
- Smooth the sealant over the opening; if neat edges are desired, use masking tape.
- The sealant can normally be painted after 24 hours.
- Firesafe FT Graphite must not be applied at temperatures lower than +5 °C.
- Apply the sealant using a sealant gun and a standard sealant finishing tool.

PACKAGING

- Plastic cartridge for standard sealant gun: contents 310 ml.
- Supplied in boxes of 25 cartridges.

STORAGE/ SHELF LIFE

- Store in a dry place, between +5 °C and +30 °C. Best stored in a cool and dark place.
- Shelf life: at least 12 months in unopened packaging.
- Must be protected from frost.

SAFETY

- The sealant is solvent free and environmentally friendly. Not known to be an irritant in the event of contact with skin, but avoid contact with eyes or mouth.
- See separate material safety data sheet for FIRESAFE FT Graphite.



Table 20: CLT wall ≥ 100 mm.		
Cable bundle (d) $\leq \varnothing 100$ mm, cable (d) $\leq \varnothing 21$ mm.	Fire resistance class	See detail, figure:
Cable bundle (d) $\leq \varnothing 100$ mm, cable (d) $\leq \varnothing 21$ mm. Opening in wall d: $\varnothing 130$ mm. Double-sided fire sealing with FIRESAFE FT Graphite.	E 90 – EI 90	Figure 20

Installation, Figure 20

- Remove any debris and dust from the opening.
- Moisten absorbent materials with water or primer.
- Seal the opening around the cable bundle in the CLT with FIRESAFE FT Graphite at a width of 15 mm and a depth of 25 mm.



Note: Apply FIRESAFE FT Graphite around the cable bundle on both sides of the wall. Width 15 mm x 25 mm depth. Apply a small amount of FT Graphite between the cables as a smoke seal.



Schematic diagram.



Table 21: CLT floor slab ≥ 140 mm.		
Cable bundle (d) $\leq \varnothing 100$ mm, cable (d) $\leq \varnothing 21$ mm.	Fire resistance class	See detail, figure:
Cable bundle (d) $\leq \varnothing 100$ mm, cable (d) $\leq \varnothing 21$ mm. Opening in floor slab d: $\varnothing 130$ mm. Double-sided fire sealing with FIRESAFE FT Graphite.	E 90 – EI 90	Figure 21

Installation, Figure 21

- Remove any debris and dust from the opening.
- Moisten absorbent materials with water or primer.
- Seal the opening around the cable bundle in the CLT with FIRESAFE FT Graphite at a width of 15 mm and a depth of 25 mm.



Note: Apply FIRESAFE FT Graphite around the cable bundle on both sides of the floor slab. Width 15 mm x 25 mm depth. Apply a small amount of FT Graphite between the cables as a smoke seal.



Schematic diagram.



Table 22: CLT wall ≥ 100 mm.		
Electrical cable conduit bundle of PVC-U plastic (d) ≤ Ø 110 mm, cable conduit (d) ≤ Ø 20 mm. C/C.	Fire resistance class	See detail, figure:
Electrical cable conduit bundle (d) ≤ Ø 110 mm, cable conduit (d) ≤ Ø 20 mm. C/C. Opening in wall d: Ø 140 mm. Double-sided fire sealing with FIRESAFE FT Graphite.	E 90 – EI 90	Figure 22

Installation, Figure 22

- Remove any debris and dust from the opening.
- Moisten absorbent materials with water or primer.
- Seal the opening around the cable conduit bundle with FIRESAFE FT Graphite at a width of 15 mm and a depth of 25 mm.



Note: Apply FIRESAFE FT Graphite around the cable conduit bundle on both sides of the wall. Width 15 mm x 25 mm depth. Apply a small amount of FT Graphite between the conduits as a smoke seal.



Schematic diagram.



Table 23: CLT floor slab ≥ 140 mm.		
Electrical cable conduit bundle of PVC-U plastic ($d \leq \varnothing 110$ mm, cable conduit ($d \leq \varnothing 20$ mm. C/C.	Fire resistance class	See detail, figure:
Electrical cable conduit bundle ($d \leq \varnothing 110$ mm, cable conduit ($d \leq \varnothing 20$ mm. C/C. Opening in floor slab $d: \varnothing 140$ mm. Double-sided fire sealing with FIRESAFE FT Graphite.	E 90 – EI 90	Figure 23

Installation, Figure 23

- Remove any debris and dust from the opening.
- Moisten absorbent materials with water or primer.
- Seal the opening around the cable conduit bundle with FIRESAFE FT Graphite at a width of 15 mm and a depth of 25 mm.

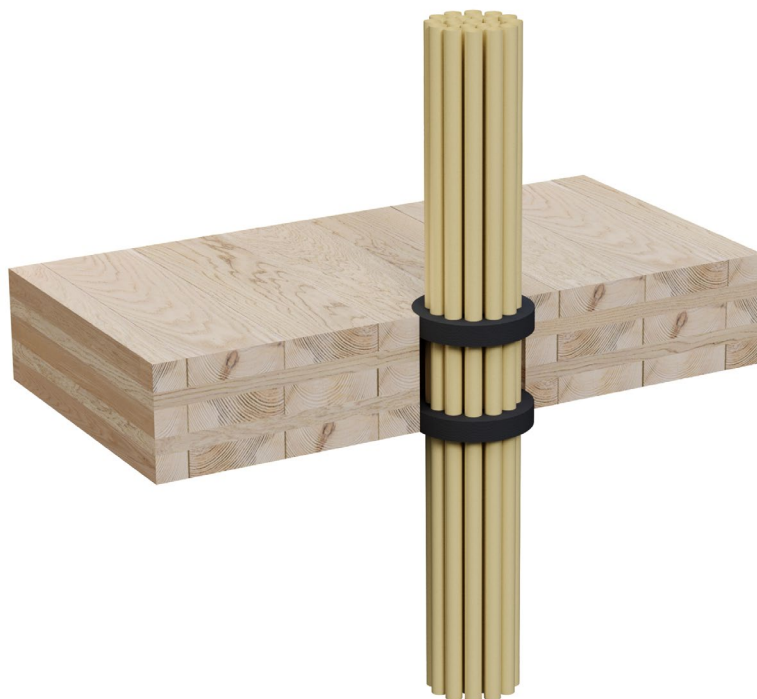

Note: Apply FIRESAFE FT Graphite around the cable conduit bundle on both sides of the floor slab. Width 15 mm x 25 mm depth. Apply a small amount of FT Graphite between the conduits as a smoke seal.



Schematic diagram.



Table 24:		CLT wall ≥ 100 mm.	
PE plastic pipe (d) $\leq \varnothing 110$ mm, (t) 3.4 mm. U/C.	Fire resistance class	See detail, figure:	
PE plastic pipe (d) $\leq \varnothing 110$ mm, (t) 3.4 mm. U/C. Opening in wall d: $\varnothing 130$ mm. Double-sided fire sealing with FIRESAFE FT Graphite.	E 90 – EI 90	Figure 24	

Installation, Figure 24

- Remove any debris and dust from the opening.
- Moisten absorbent materials with water or primer.
- Seal the opening between the pipe and the CLT with FIRESAFE FT Graphite at a width of 10 mm and a depth of 25 mm.

Note: Apply FIRESAFE FT Graphite around the plastic pipe on both sides of the wall. Width 10 mm x 25 mm depth.



Schematic diagram.



Table 25: CLT floor slab ≥ 140 mm.		
PE plastic pipe (d) $\leq \varnothing 110$ mm, (t) 3.4 mm. U/C.	Fire resistance class	See detail, figure:
PE plastic pipe (d) $\leq \varnothing 110$ mm, (t) 3.4 mm. U/C. Opening in floor slab d: $\varnothing 140$ mm. Double-sided fire sealing with FIRESAFE FT Graphite.	E 90 – EI 90	Figure 25

Installation, Figure 25

- Remove any debris and dust from the opening.
- Moisten absorbent materials with water or primer.
- Seal the opening between the pipe and the CLT with FIRESAFE FT Graphite at a width of 15 mm and a depth of 25 mm.



Note: Apply FIRESAFE FT Graphite around the plastic pipe on both sides of the floor slab. Width 15 mm x 25 mm depth.



Schematic diagram.



Table 26: CLT wall ≥ 100 mm.		
PP plastic pipe (d) ≤ Ø 110 mm, (t) 6.3 mm. U/C.	Fire resistance class	See detail, figure:
PP plastic pipe (d) ≤ Ø 110 mm, (t) 6.3 mm. U/C. Opening in wall d: Ø 130 mm. Double-sided fire sealing with FIRESAFE FT Graphite.	E 90 – EI 90	Figure 26

Installation, Figure 26

- Remove any debris and dust from the opening.
- Moisten absorbent materials with water or primer.
- Seal the opening between the pipe and the CLT with FIRESAFE FT Graphite at a width of 10 mm and a depth of 25 mm.

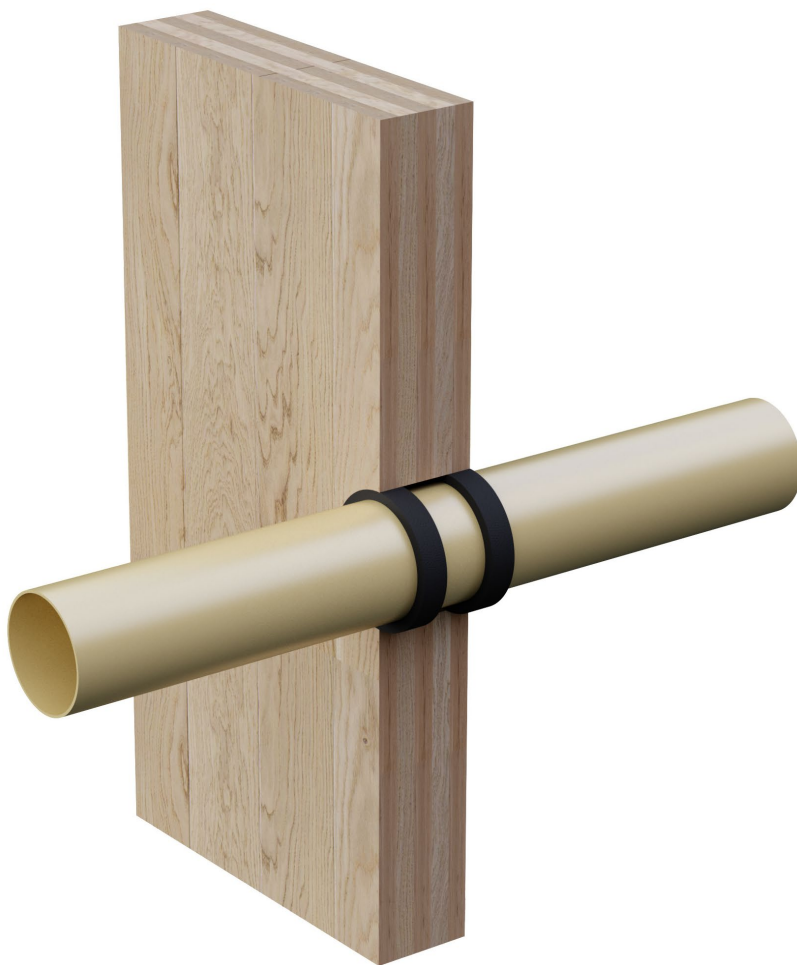

Note: Apply FIRESAFE FT Graphite around the plastic pipe on both sides of the wall. Width 10 mm x 25 mm depth.



Schematic diagram.



Table 27: CLT floor slab ≥ 140 mm.		
PP plastic pipe (d) $\leq \varnothing 110$ mm, (t) 6.3 mm. U/C.	Fire resistance class	See detail, figure:
PP plastic pipe (d) $\leq \varnothing 110$ mm, (t) 6.3 mm. U/C. Opening in floor slab d: $\varnothing 140$ mm. Double-sided fire sealing with FIRESAFE FT Graphite.	E 90 – EI 90	Figure 27

Installation, Figure 27

- Remove any debris and dust from the opening.
- Moisten absorbent materials with water or primer.
- Seal the opening between the pipe and the CLT with FIRESAFE FT Graphite at a width of 15 mm and a depth of 25 mm.

Note: Apply FIRESAFE FT Graphite around the plastic pipe on both sides of the floor slab. Width 15 mm x 25 mm depth.



Schematic diagram.



Table 28: CLT floor slab ≥ 140 mm.		
Copper and steel pipes (d) $\leq \varnothing 12$ mm, (t) 1.0 mm. C/U.	Fire resistance class	See detail, figure:
Copper and steel pipes (d) $\leq \varnothing 12$ mm, (t) 1.0 mm. 13 mm Armaflex AF. C/U. Opening in floor slab d: $\varnothing 68$ mm. Double-sided fire sealing with FIRESAFE FT Graphite.	E 90 – EI 90	Figure 28

Installation, Figure 28

- Remove any debris and dust from the opening.
- Moisten absorbent materials with water or primer.
- Seal the opening around the insulated pipe in the CLT with FIRESAFE FT Graphite at a width of 15 mm and a depth of 25 mm.

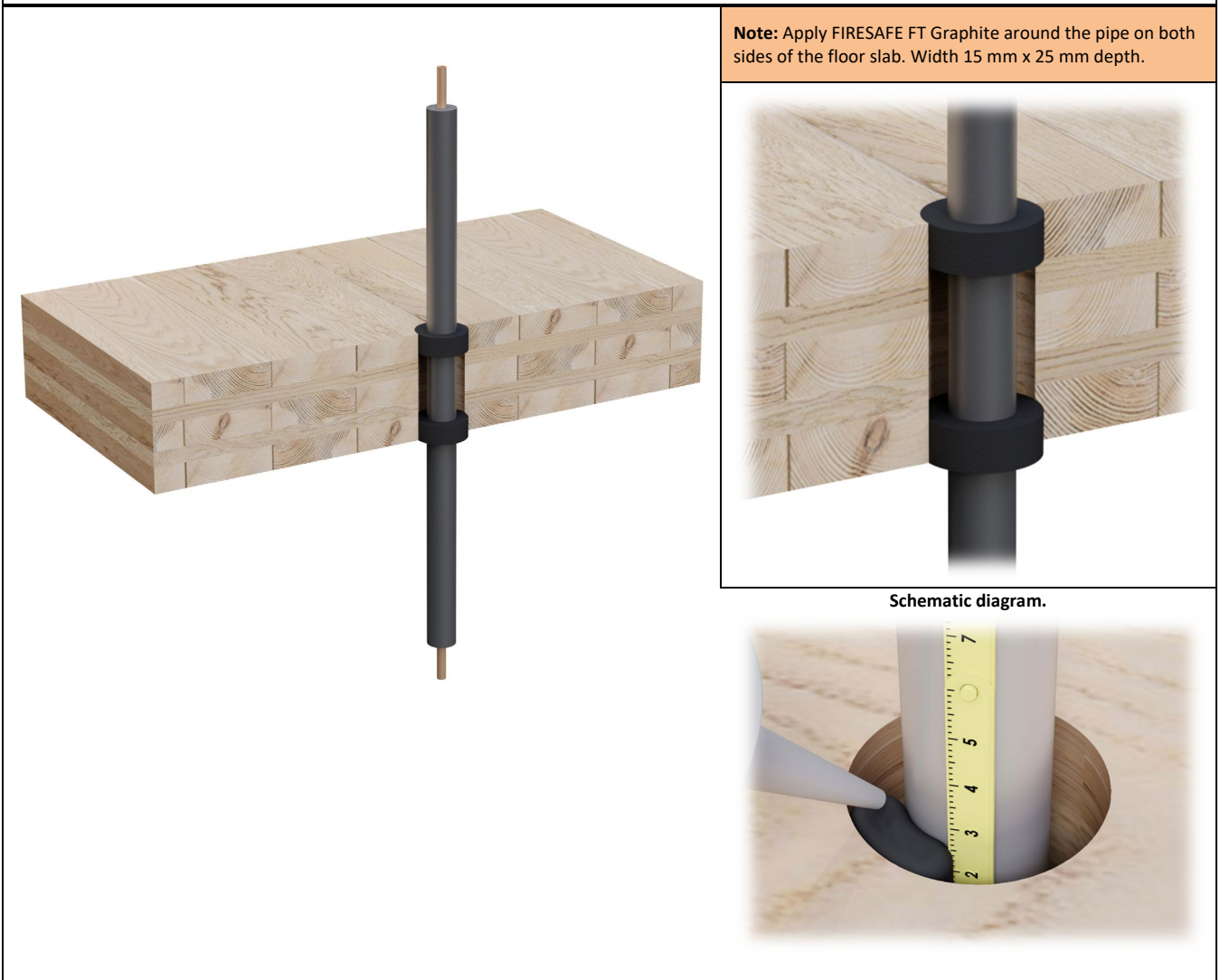

*Pipes insulated with 13 mm cellular rubber of type Armaflex AF. Fire rating, Euroclass B/BL, s3-d0.

LS: Continuous pipe insulation, 13 mm thick, with 350 mm extending out on each side of the floor slab.

CS: The specified insulation must run the entire length of the pipe or a minimum of 850 mm, including in the penetration itself.

Table 29: CLT floor slab ≥ 140 mm.		
Copper and steel pipes (d) $\leq \varnothing 76.1$ mm, (t) 2.0 mm. C/U.	Fire resistance class	See detail, figure:
Copper and steel pipes (d) $\leq \varnothing 76.1$ mm, (t) 2.0 mm. 13 mm Armaflex AF. C/U. Opening in floor slab d: $\varnothing 132$ mm. Double-sided fire sealing with FIRESAFE FT Graphite.	E 90 – EI 30	Figure 29

Installation, Figure 29

- Remove any debris and dust from the opening.
- Moisten absorbent materials with water or primer.
- Seal the opening around the insulated pipe in the CLT with FIRESAFE FT Graphite at a width of 15 mm and a depth of 25 mm.

Note: Apply FIRESAFE FT Graphite around the pipe on both sides of the floor slab. Width 15 mm x 25 mm depth.



Schematic diagram.



*Pipes insulated with 13 mm cellular rubber of type Armaflex AF. Fire rating, Euroclass B/BL, s3-d0.

LS: Continuous pipe insulation, 13 mm thick, with 350 mm extending out on each side of the floor slab.

CS: The specified insulation must run the entire length of the pipe or a minimum of 850 mm, including in the penetration itself.

Table 30: CLT floor slab ≥ 140 mm.		
Aluminium pipe of type PE-X (d) $\leq \varnothing 16$ mm, (t) 2.25 mm. U/C.	Fire resistance class	See detail, figure:
Alu PE-X (d) $\leq \varnothing 16$ mm, (t) 2.25 mm. 13 mm Armaflex AF. U/C. Opening in floor slab d: $\varnothing 72$ mm. Double-sided fire sealing with FIRESAFE FT Graphite.	E 90 – EI 90	Figure 30

Installation, Figure 30

- Remove any debris and dust from the opening.
- Moisten absorbent materials with water or primer.
- Seal the opening around the insulated pipe in the CLT with FIRESAFE FT Graphite at a width of 15 mm and a depth of 25 mm.



Note: Apply FIRESAFE FT Graphite around the pipe on both sides of the floor slab. Width 15 mm x 25 mm depth.



Schematic diagram.



*Pipes insulated with 13 mm cellular rubber of type Armaflex AF. Fire rating, Euroclass B/BL, s3-d0.

LS: Continuous pipe insulation, 13 mm thick, with 350 mm extending out on each side of the floor slab.

CS: The specified insulation must run the entire length of the pipe or a minimum of 850 mm, including in the penetration itself.

INSTALLATION MANUAL

FIRE SEALING IN CLT CONSTRUCTIONS

Fire Stopping System Hand Book

FIRESAFE /

Date: 19.11.2021

Prepared by: Pål Paulsen

Controlled by: Hallvard K Engøy

Rev.: 01

Table 31: CLT floor slab ≥ 140 mm.		
Aluminium pipe of type PE-X (d) $\leq \varnothing 63$ mm, (t) 4.5 mm. C/U.	Fire resistance class	See detail, figure:
Alu PE-X (d) $\leq \varnothing 63$ mm, (t) 4.5 mm. 13 mm Armaflex AF. C/U. Opening in floor slab d: $\varnothing 119$ mm. Double-sided fire sealing with FIRESAFE FT Graphite.	E 90 – EI 90	Figure 31

Installation, Figure 31

- Remove any debris and dust from the opening.
- Moisten absorbent materials with water or primer.
- Seal the opening around the insulated pipe in the CLT with FIRESAFE FT Graphite at a width of 15 mm and a depth of 25 mm.



Note: Apply FIRESAFE FT Graphite around the pipe on both sides of the floor slab. Width 15 mm x 25 mm depth.



Schematic diagram.



*Pipes insulated with 13 mm cellular rubber of type Armaflex AF. Fire rating, Euroclass B/BL, s3-d0.

LS: Continuous pipe insulation, 13 mm thick, with 350 mm extending out on each side of the floor slab.

CS: The specified insulation must run the entire length of the pipe or a minimum of 850 mm, including in the penetration itself.

FIRESAFE /

All information in this data sheet is to be regarded as normative values obtained from tests and our collective knowledge and experience of the product. This data must not be used as a basis for or verification of other tests or systems. Firesafe AS accepts no liability for other use or misuse of the product. Users are responsible for ensuring they use the latest version of this document. Please check our website www.firesafe.no. This document may not be copied without the written consent of Firesafe AS.

Table 32: CLT floor slab ≥ 140 mm.		
Steel pipe (d) $\leq \varnothing 42$ mm, (t) 2.6 mm. U/C.	Fire resistance class	See detail, figure:
Steel pipe (d) $\leq \varnothing 42$ mm, (t) 2.6 mm. 13 mm Armaflex AF. U/C. Opening in floor slab d: $\varnothing 98$ mm. Double-sided fire sealing with FIRESAFE FT Graphite.	E 90 – EI 90	Figure 32

Installation, Figure 32

- Remove any debris and dust from the opening.
- Moisten absorbent materials with water or primer.
- Seal the opening around the insulated pipe in the CLT with FIRESAFE FT Graphite at a width of 15 mm and a depth of 25 mm.



Note: Apply FIRESAFE FT Graphite around the pipe on both sides of the floor slab. Width 15 mm x 25 mm depth.



Schematic diagram.



*Pipes insulated with 13 mm cellular rubber of type Armaflex AF. Fire rating, Euroclass B/BL, s3-d0.

LS: Continuous pipe insulation, 13 mm thick, with 350 mm extending out on each side of the floor slab.

CS: The specified insulation must run the entire length of the pipe or a minimum of 850 mm, including in the penetration itself.

Table 33: CLT floor slab ≥ 140 mm.		
Steel pipe (d) $\leq \varnothing 89.9$ mm, (t) 3.0 mm. C/U.	Fire resistance class	See detail, figure:
Steel pipe (d) $\leq \varnothing 89.9$ mm, (t) 3.0 mm. 13 mm Armaflex AF. C/U. Opening in floor slab d: $\varnothing 146$ mm. Double-sided fire sealing with FIRESAFE FT Graphite.	E 90 – EI 90	Figure 33

Installation, Figure 33

- Remove any debris and dust from the opening.
- Moisten absorbent materials with water or primer.
- Seal the opening around the insulated pipe in the CLT with FIRESAFE FT Graphite at a width of 15 mm and a depth of 25 mm.



Note: Apply FIRESAFE FT Graphite around the pipe on both sides of the floor slab. Width 15 mm x 25 mm depth.



Schematic diagram.



*Pipes insulated with 13 mm cellular rubber of type Armaflex AF. Fire rating, Euroclass B/BL, s3-d0.

LS: Continuous pipe insulation, 13 mm thick, with 350 mm extending out on each side of the floor slab.

CS: The specified insulation must run the entire length of the pipe or a minimum of 850 mm, including in the penetration itself.

FIRESAFE GPG MORTAR

PRODUCT DESCRIPTION

FIRESAFE GPG MORTAR is a powder that consists of gypsum, perlite and fibreglass, which, with the addition of water, turns into a white fire sealing compound.

GPG is a gypsum-based, fast-curing fire sealing compound with high mechanical strength and good sound insulation properties.

GPG increases in volume as it cures and has excellent adhesion to all building materials.

GPG is mainly used as a fire sealing in large or small holes and openings around technical installations such as cables, pipes and ventilation ducts, as well as unused apertures.

The product's field of application is category Z2: indoors with an ambient humidity lower than 85% RH, temperature not below 0 °C, protected from rain and UV radiation.

AREAS OF USE

- Fire sealing compound for all types of installation penetrations.

CERTIFICATION / FIRE RESISTANCE

- FIRESAFE GPG MORTAR has been tested in accordance with NS-EN 1366-3 (2009) and NS-EN 1366-4 (2009), as well as EN 13501-1/2.
- Certified in accordance with ETA 15/0026. FIRESAFE GPG MORTAR.
- Norwegian product documentation issued by RISE Fire Research AS. RISEFR AA-050.
- Fire resistance EI 30 to EI 240 with extensive areas of application for walls and floors.
- Fire-rated walls in accordance with EN 1363-1.: Plaster or masonry walls/precast structure (density 600–650 kg/m³) ≥100 mm.
- Fire-rated Masonry floor slabs/precast structure (density 600–650 kg/m³) ≥ 150 mm.
- Fire resistance class EI 90 in CLT structures (cross-laminated timber structures).
- For more information, see the DoP on www.firesafe.no.

APPLICATION

- GPG powder is added to a bucket filled with a little water in the bottom, the mortar is mixed with a trowel or mixed for about ½ minute with a drill to achieve a smooth mixture at the desired consistency.
- Initial curing time is 75 minutes in accordance with NS-EN 480-2, but may vary depending on the mixing ratio between water and GPG.
- FS retarder may be added to delay the curing time.
- A firm mixture is made with 4 parts GPG and 1 part water.
- A fluid mixture is made with 2 parts GPG and 1 part water.
- Apertures must be cleaned of dust and dirt before applying the fire sealing.
- Metal pipes must always be rust proofed before applying the fire sealing.
- Masking tape should be used around apertures for an attractive finish.
- Apertures should be insulated with loose mineral wool or sheets of mineral wool before applying the fire sealing.
- Penetration sealing is carried out with standard masonry tools.
- Tools should be cleaned with water.

PACKAGING

- 20 litre bag. 10 litre and 5 litre tubs.

Tubs of GPG contain sealed plastic bags, which make for easy handling, as users can remove the plastic bags and use the tub to mix the desired amount.

STORAGE

- Store dry and frost-free. The shelf life of the product is virtually unlimited.

SAFETY FACTORS

- FIRESAFE GPG MORTAR complies with GEV requirements, and the result corresponds with EMICODE class EC 1PLUS.
- The product also meets the requirements of the M1 classification, which is based on ISO 16000.
- There are no health risks or safety issues associated with the product.



Table 34: CLT wall ≥ 100 mm.		
Cable bundle (d) $\leq \varnothing 80$ mm, cable (d) $\leq \varnothing 21$ mm.	Fire resistance class	See detail, figure:
Cable bundle (d) $\leq \varnothing 80$ mm, cable (d) $\leq \varnothing 21$ mm. Opening in wall d: $\varnothing 140$ mm. Fire sealing using FIRESAFE GPG MORTAR.	E 90 – EI 90	Figure 34

Installation, Figure 34

- Remove any debris and dust from the opening.
- Moisten absorbent materials with water or primer.
- GPG is mixed to a firm consistency with 4 parts GPG and 1 part water.
- Openings around cable bundles in CLT are sealed with FIRESAFE GPG MORTAR to a width of 30 mm and a depth of 100 mm.

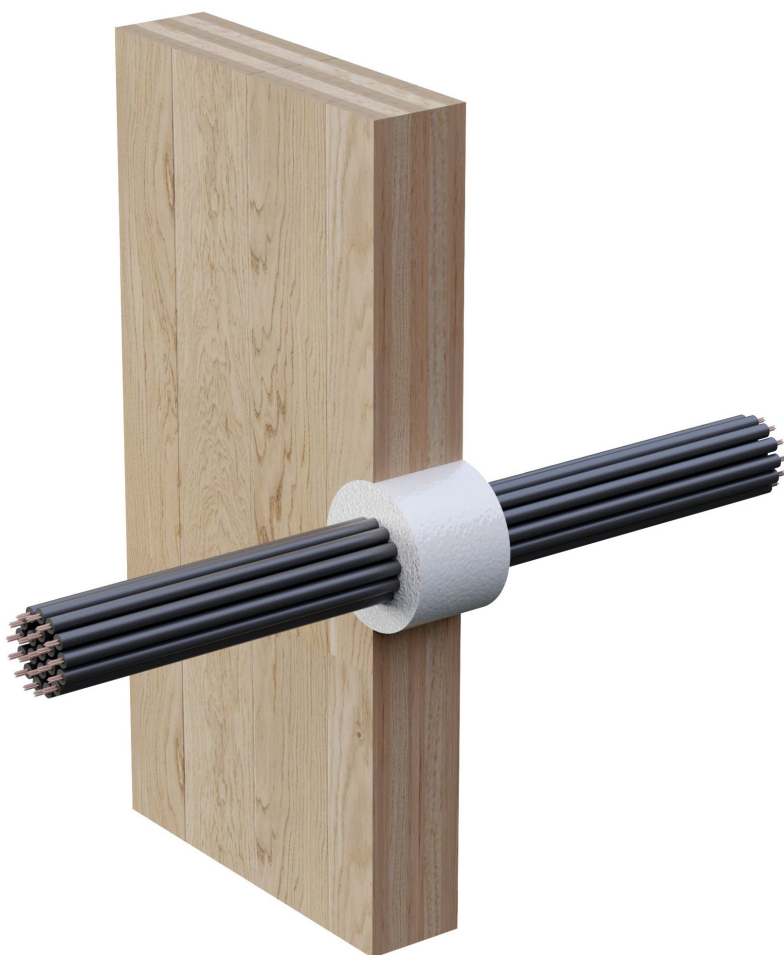

Note: Apply FIRESAFE GPG MORTAR around the cable bundles through the wall. Minimum depth of 100 mm. Apply a small amount of GPG between the cables as a smoke seal.

For wall thicknesses >100 mm, apply GPG sealant to a depth of 50 mm on each side of the wall.



General rules: For single or multiple cables, the distance between the cable and the edge of the sealant must be ≥ 30 mm. See distance a1: Fig 1.

The distance between multiple holes must be ≥ 200 mm. See distance a2: Fig 1.

Fig 1.

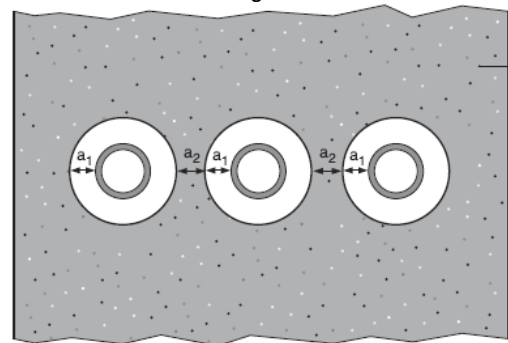

Table 35: CLT floor slab ≥ 140 mm.		
Cable bundle (d) $\leq \varnothing 80$ mm, cable (d) $\leq \varnothing 21$ mm.	Fire resistance class	See detail, figure:
Cable bundle (d) $\leq \varnothing 80$ mm, cable (d) $\leq \varnothing 21$ mm. Opening in floor slab d: $\varnothing 140$ mm. Fire sealing using FIRESAFE GPG MORTAR.	E 90 – EI 90	Figure 35

Installation, Figure 35

- Remove any debris and dust from the opening.
- Moisten absorbent materials with water or primer.
- GPG is mixed to a fluid consistency with 2 parts GPG and 1 part water.
- Openings around cable bundles in CLT are sealed with FIRESAFE GPG MORTAR to a width of 30 mm and a depth of 140 mm.
- Before applying the fire sealing, standard plasterboard (12.5 mm) can be fixed to the underside of the floor slab.
- The plasterboard does not need to be removed after using GPG MORTAR to create a fire sealing.



Note: Apply FIRESAFE GPG MORTAR around the cable bundles through the entire floor slab. Min 140 mm fire sealing depth in the aperture. For floor slab thicknesses > 140 mm, a GPG Fire sealing is always applied to the underside of the CLT floor slab, min 140 mm fire sealing depth. Apply a small amount of GPG between the cables as a smoke seal.



General rules: For single or multiple cables, the distance between the cable and the edge of the sealant must be ≥ 30 mm. See distance a1: Fig 1.
The distance between multiple holes must be ≥ 200 mm. See distance a2: Fig 1.

Fig 1.

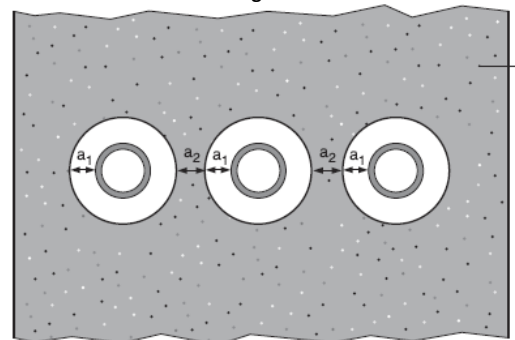
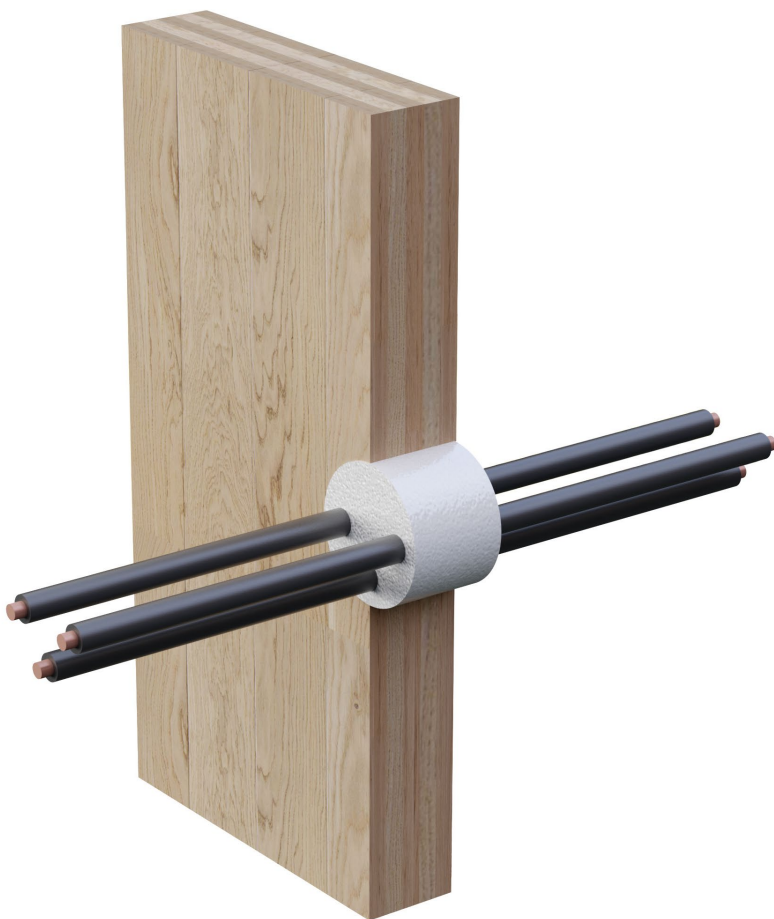

Table 36: CLT wall ≥ 100 mm.		
Multiple or single cables ($d \leq \varnothing 50$ mm, cable ($d \leq \varnothing 50$ mm.	Fire resistance class	See detail, figure:
Multiple or single cables ($d \leq \varnothing 50$ mm, cable ($d \leq \varnothing 50$ mm. Opening in wall d: $\varnothing 140$ mm. Fire sealing using FIRESAFE GPG MORTAR.	E 90 – EI 60	Figure 36

Installation, Figure 36

- Remove any debris and dust from the opening.
- Moisten absorbent materials with water or primer.
- GPG is mixed to a firm consistency with 4 parts GPG and 1 part water.
- Seal openings around cables in CLT with FIRESAFE GPG MORTAR to a depth of 100 mm.

Note: Apply FIRESAFE GPG MORTAR around the cables through the wall. Minimum thickness of 100 mm. For wall thicknesses >100 mm, apply GPG sealant to a depth of 50 mm on each side of the wall.



General rules: For single or multiple cables, the distance between the cable and the edge of the sealant must be ≥ 15 mm. See distance a1: Fig 1.
The distance between multiple holes must be ≥ 200 mm. See distance a2: Fig 1.

Fig 1.

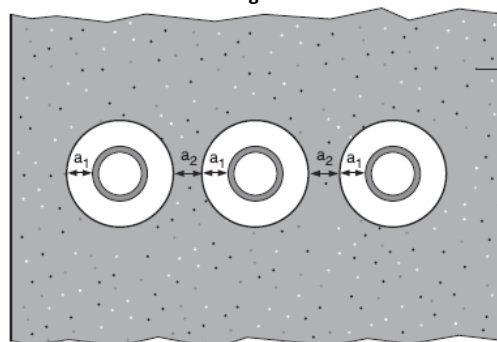
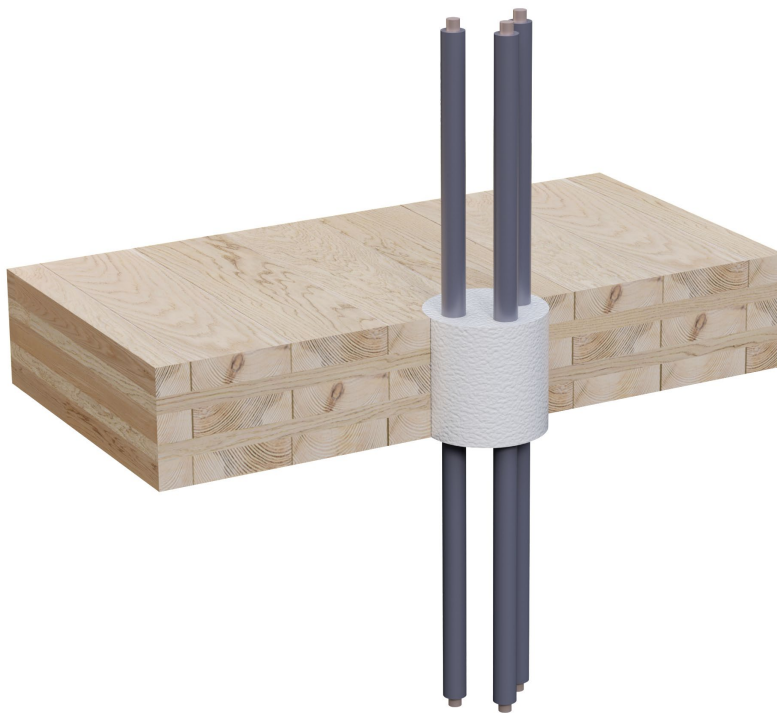

Table 37: CLT floor slab ≥ 140 mm.		
Multiple or single cables (d) $\leq \varnothing 50$ mm, cable (d) $\leq \varnothing 50$ mm.	Fire resistance class	See detail, figure:
Multiple or single cables (d) $\leq \varnothing 50$ mm, cable (d) $\leq \varnothing 50$ mm. Opening in floor slab d: $\varnothing 140$ mm. Fire sealing using FIRESAFE GPG MORTAR.	E 90 – EI 90	Figure 37

Installation, Figure 37

- Remove any debris and dust from the opening.
- Moisten absorbent materials with water or primer.
- GPG is mixed to a fluid consistency with 2 parts GPG and 1 part water.
- Seal openings around cables in CLT with FIRESAFE GPG MORTAR to a depth of 140 mm.
- Before applying the fire sealing, standard plasterboard (12.5 mm) can be fixed to the underside of the floor slab.
- The plasterboard does not need to be removed after using GPG MORTAR to create a fire sealing.



Note: Apply FIRESAFE GPG MORTAR around the cable bundles through the entire floor slab. Min 140 mm Fire Stopping depth in the aperture. For floor slab thicknesses > 140 mm, a GPG fire sealing is always applied to the underside of the CLT floor slab, min 140 mm fire sealing depth.



General rules: For single or multiple cables, the distance between the cable and the edge of the sealant must be ≥ 15 mm. See distance a1: Fig 1.

The distance between multiple holes must be ≥ 200 mm. See distance a2: Fig 1.

Fig 1.

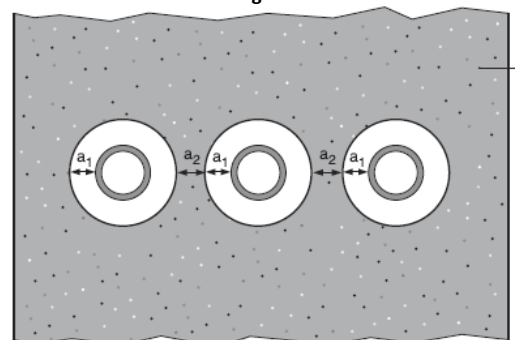
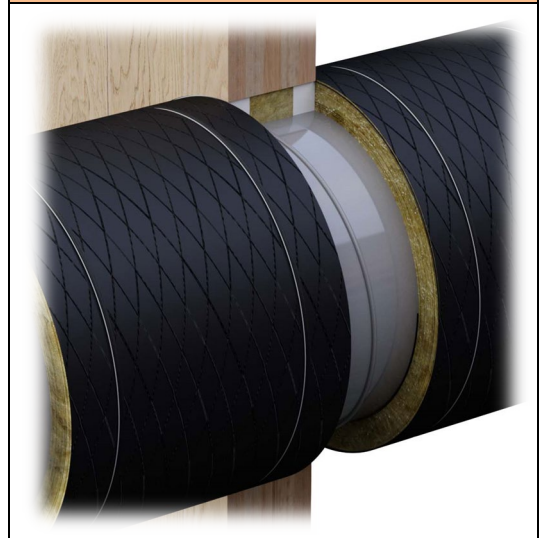

Table 38: CLT wall ≥ 100 mm.			
Ventilation duct (d) $\leq \varnothing 300$ mm. C/U.	Infill, type, density, thickness (mm)	Fire resistance class	See detail, figure:
Ventilation duct (d) $\leq \varnothing 300$ mm, (t) 0.9 mm. C/U. 30 mm PAROC Hvac Section Fire Mat. Opening in wall d: $\varnothing 360$ mm. Double-sided fire sealing using FIRESAFE GPG MORTAR.	Mineral wool density 50 kg/m ³ , thickness 50 mm	E 90 – EI 60	Figure 38

Installation, Figure 38

- Remove any debris and dust from the opening.
- Moisten absorbent materials with water or primer.
- Push mineral wool infill into the opening in the wall. Mineral wool density ≥ 50 kg/m³, thickness 50 mm.
- GPG is mixed to a firm consistency with 4 parts GPG and 1 part water.
- Seal the opening around the ventilation duct with FIRESAFE GPG MORTAR to a depth of 25 mm on each side of the wall.
- Apply duct insulation after applying FIRESAFE GPG MORTAR as a Fire Stopping.
- Apply duct insulation with a mesh mat with a 50 mm overlap on longitudinal joints. Stitch all longitudinal and transverse joints with galvanised steel wire or fix the joints with hooks using special pliers. Stitch length and hook distance 50–100 mm.
- Tie round duct insulation around circular ducts with steel wire CC 200 mm.

Note: Apply FIRESAFE GPG MORTAR around the duct on both sides of the wall. Width 30 mm x 25 mm depth.



*Duct insulation type PAROC Hvac Fire Mat BlackCoat T of mineral wool, density 90 kg/m³. Thickness 30 mm. Fire rating A2 \perp -s1, d0.
Or mineral wool duct insulation with the same density, thickness and fire rating.

LI: Specified insulation locally with specified length from the wall on both sides (minimum 1,200 mm), excluding the penetration itself.

CI: Specified insulation continuous through the entire length of the duct, excluding the penetration itself.

Table 39: CLT floor slab ≥ 140 mm.			
Ventilation duct (d) $\leq \varnothing 300$ mm. C/U.	Infill, type, density, thickness (mm)	Fire resistance class	See detail, figure:
Ventilation duct (d) $\leq \varnothing 300$ mm, (t) 0.9 mm. C/U. 30 mm PAROC Hvac Section Fire Mat. Opening in floor slab d: $\varnothing 360$ mm. Double-sided fire sealing using FIRESAFE GPG MORTAR.	Mineral wool density 50 kg/m^3 , thickness 50 mm	E 90 – EI 90	Figure 39

Installation, Figure 39

- Remove any debris and dust from the opening.
- Moisten absorbent materials with water or primer.
- Push mineral wool infill into the opening in the floor slab. Mineral wool density $\geq 50 \text{ kg/m}^3$, thickness 90 mm.
- GPG is mixed to a firm consistency with 4 parts GPG and 1 part water.
- Seal the opening around the ventilation duct with FIRESAFE GPG MORTAR to a depth of 25 mm on each side of the floor slab.
- Apply duct insulation after applying FIRESAFE GPG MORTAR as a fire sealing.
- Apply duct insulation with a mesh mat with a 50 mm overlap on longitudinal joints. Stitch all longitudinal and transverse joints with galvanised steel wire or fix the joints with hooks using special pliers. Stitch length and hook distance 50–100 mm.
- Tie round duct insulation around circular ducts with steel wire CC 200 mm.

Note: Apply FIRESAFE GPG MORTAR around the duct on both sides of the floor slab. Width 30 mm x 25 mm depth.



*Duct insulation type PAROC Hvac Fire Mat BlackCoat T of mineral wool, density 90 kg/m^3 . Thickness 30 mm. Fire rating A2 L-s1, d0 .
Or mineral wool duct insulation with the same density, thickness and fire rating.

L: Specified insulation locally with specified length from the floor slab on both sides (minimum 1,200 mm), excluding the penetration itself.

CI: Specified insulation continuous through the entire length of the duct, excluding the penetration itself.

Table 40: CLT wall ≥ 100 mm.			
Empty rectangular aperture $\leq 200 \times 140$ mm.	Infill, type, density, thickness (mm)	Fire resistance class	See detail, figure:
Empty rectangular aperture $\leq 200 \times 140$ mm, or circular aperture with the same area. Double-sided fire sealing using FIRESAFE GPG MORTAR.	Mineral wool density 150 kg/m^3 , thickness 20 mm	E 90 – EI 90	Figure 40

Installation, Figure 40

- Remove any debris and dust from the opening.
- Moisten absorbent materials with water or primer.
- Push mineral wool infill into the opening in the wall. Mineral wool density $\geq 150 \text{ kg/m}^3$, thickness 20 mm.
- GPG is mixed to a firm consistency with 4 parts GPG and 1 part water.
- Seal the opening in the CLT with FIRESAFE GPG MORTAR to a depth of 40 mm on each side of the wall.
- FIRESAFE GPG MORTAR can also be used as a fire sealing in the opening in the wall without mineral wool infill.

Note: Apply FIRESAFE GPG MORTAR in the opening on both sides of the wall. 2 x 40 mm fire sealing depth or a continuous Fire Stopping without mineral wool infill.



Table 41: CLT floor slab ≥ 140 mm.			
Empty rectangular aperture $\leq 200 \times 140$ mm.	Infill, type, density, thickness (mm)	Fire resistance class	See detail, figure:
Empty rectangular aperture $\leq 200 \times 140$ mm, or circular aperture with the same area. Double-sided fire sealing using FIRESAFE GPG MORTAR.	Mineral wool density 150 kg/m^3 , thickness 50 mm	E 90 – EI 90	Figure 41

Installation, Figure 41

- Remove any debris and dust from the opening.
- Moisten absorbent materials with water or primer.
- Push mineral wool infill into the opening in the floor slab. Mineral wool density $\geq 150 \text{ kg/m}^3$, thickness 50 mm.
- GPG is mixed to a firm consistency with 4 parts GPG and 1 part water.
- FIRESAFE GPG MORTAR can also be used as a fire sealing in the opening in the floor slab without mineral wool infill.



Note: Apply FIRESAFE GPG MORTAR in the opening on both sides of the floor slab. 2 x 45 mm fire sealing depth or a continuous fire sealing without mineral wool infill.



Table 42: CLT wall ≥ 100 mm.			
Empty circular aperture $\leq \varnothing 140$ mm.	Infill, type, density, thickness (mm)	Fire resistance class	See detail, figure:
Empty circular aperture $\leq \varnothing 140$ mm. One-sided fire sealing with FIRESAFE GPG MORTAR. Installed on the exposed or unexposed side.	Mineral wool density 150 kg/m^3 , thickness 50 mm	E 90 – EI 60	Figure 42

Installation, Figure 42

- Remove any debris and dust from the opening.
- Moisten absorbent materials with water or primer.
- Push mineral wool infill into the opening on one side of the wall. Mineral wool density $\geq 150 \text{ kg/m}^3$, thickness 50 mm.
- GPG is mixed to a firm consistency with 4 parts GPG and 1 part water.
- Seal the opening in the CLT with FIRESAFE GPG MORTAR to a depth of 50 mm on one side of the wall.
- FIRESAFE GPG MORTAR can also be used as a fire sealing in the opening in the wall without mineral wool infill.

Note: Apply FIRESAFE GPG MORTAR in the opening on one side of the wall. Fire sealing depth 50 mm. Alternatively, a fire seal can be applied throughout the wall without mineral wool infill.



Table 43: CLT floor slab ≥ 140 mm.			
Empty circular aperture $\leq \varnothing 140$ mm.	Infill, type, density, thickness (mm)	Fire resistance class	See detail, figure:
Empty circular aperture $\leq \varnothing 140$ mm. One-sided fire sealing with FIRESAFE GPG MORTAR. Installed on the exposed or unexposed side.	Mineral wool density 150 kg/m^3 , thickness 50 mm	E 90 – EI 90	Figure 43

Installation, Figure 43

- Remove any debris and dust from the opening.
- Moisten absorbent materials with water or primer.
- Push mineral wool infill into the opening on one side of the floor slab. Mineral wool density $\geq 150 \text{ kg/m}^3$, thickness 50 mm.
- GPG is mixed to a firm consistency with 4 parts GPG and 1 part water.
- FIRESAFE GPG MORTAR can also be used as a fire sealing in the opening in the floor slab without mineral wool infill.



Note: Apply FIRESAFE GPG MORTAR in the opening on one side of the floor slab. Fire sealing depth 50 mm. Alternatively, a fire seal can be applied throughout the wall without mineral wool infill.



Table 44: CLT floor slab ≥ 140 mm.		
Cast iron pipe (d) $\leq \varnothing 110$ mm, (t) 3.5 mm. C/U.	Fire resistance class	See detail, figure:
Cast iron pipe (d) $\leq \varnothing 110$ mm, (t) 3.5 mm. C/U. Opening in floor slab d: $\varnothing 160$ mm. Fire sealing using FIRESAFE GPG MORTAR.	E 90 – EI 60	Figure 44

Installation, Figure 44

- Remove any debris and dust from the opening.
- Moisten absorbent materials with water or primer.
- GPG is mixed to a firm consistency with 4 parts GPG and 1 part water.
- Seal the opening around the pipe with FIRESAFE GPG MORTAR to a depth of 250 mm in the floor slab.
- For floor slabs less than 250 mm thick, make a casing around the pipe on the upper side of the CLT floor slab to a width of 25 mm so that the total fire sealing thickness with GPG is 250 mm.

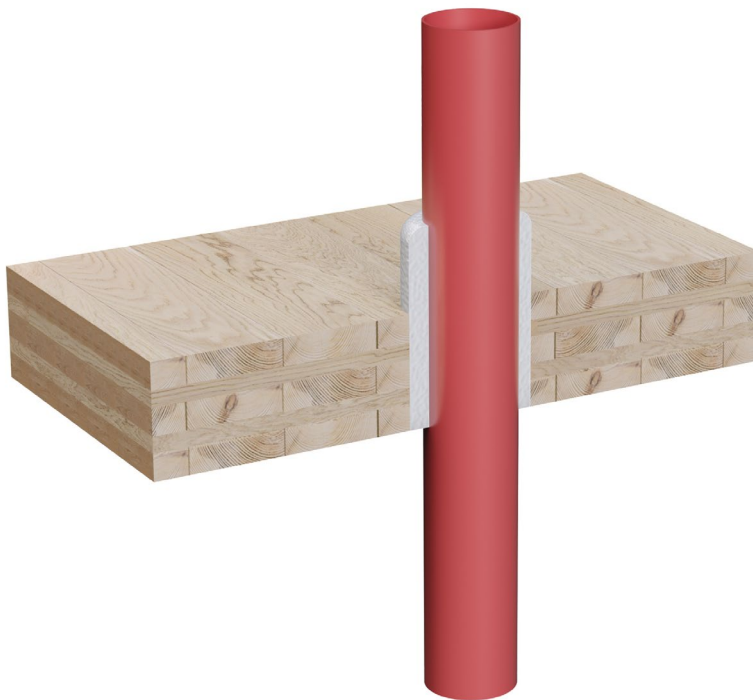

Note: Apply FIRESAFE GPG MORTAR around the pipe. Width 25 mm x 250 mm depth.

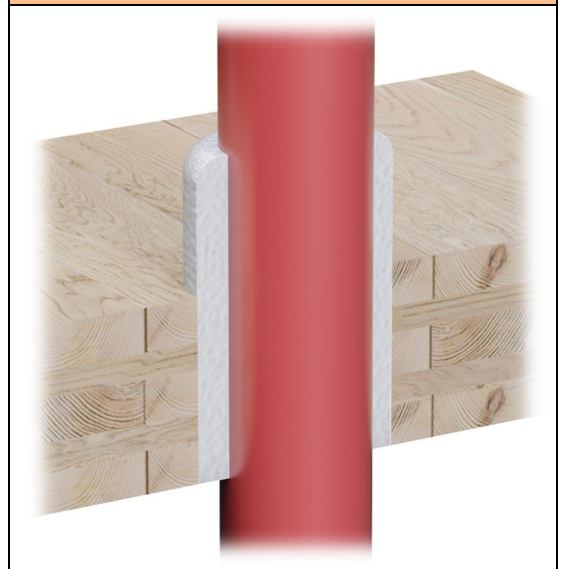

General rules: For single pipes, the distance between the pipe and the edge of the sealant must be ≥ 25 mm. See distance a1: **Fig 1.**

The distance between multiple holes must be ≥ 200 mm. See distance a2: **Fig 1.**

Fig 1.

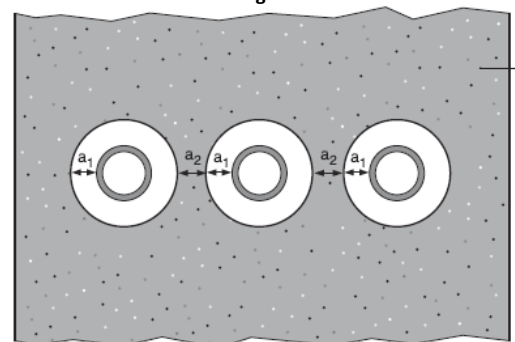
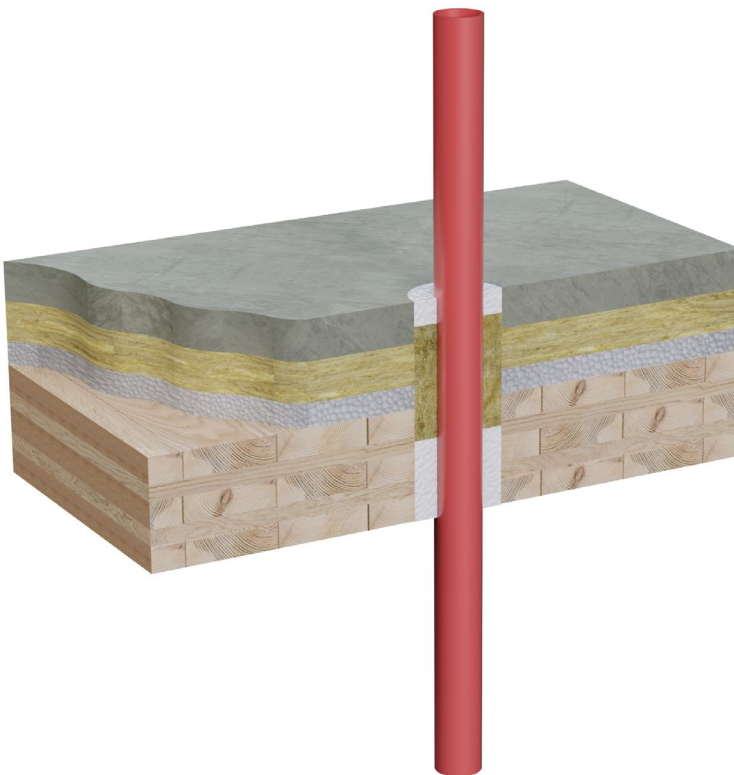

Table 45: CLT floor slab ≥ 140 mm with screed. Total floor slab thickness ≥ 270 mm		
Cast iron pipe (d) $\leq \varnothing 58$ mm, (t) 3.5 mm. C/U.	Fire resistance class	See detail, figure:
Cast iron pipe (d) $\leq \varnothing 58$ mm, (t) 3.5 mm. C/U. Opening in floor slab d: $\varnothing 118$ mm. Double-sided fire sealing using FIRESAFE GPG MORTAR. Installed on the exposed or unexposed side.	E 90 – EI 90	Figure 45

Installation, Figure 45

- Remove any debris and dust from the opening.
- Moisten absorbent materials with water or primer.
- GPG is mixed to a firm consistency with 4 parts GPG and 1 part water, or to a fluid consistency when using plasterboard on the underside of the floor slab.
- Seal the opening around the pipe with FIRESAFE GPG MORTAR to a depth of 100 mm in underside of the CLT floor slab.
- Fill the opening between the pipe and the edge of the sealant with loose mineral wool, density ≥ 50 kg/m³.
- Seal the opening between the pipe and the edge of the sealant with FIRESAFE GPG MORTAR to a depth of 30 mm on the top side of the cement floor slab. FIRESAFE GPG MORTAR can also be used as a fire seal in the opening in the floor slab without mineral wool infill.
- Before applying the Fire Stopping, standard plasterboard (12.5 mm) can be fixed to the underside of the floor slab.
- The plasterboard does not need to be removed after using GPG MORTAR to create a fire sealing.



Note: Apply FIRESAFE GPG MORTAR around the pipe. Fire sealing width 30 mm x 100 mm depth on the underside of the CLT floor slab. Fire Stopping width 30 mm x 30 mm depth on the top side of the CLT floor slab.

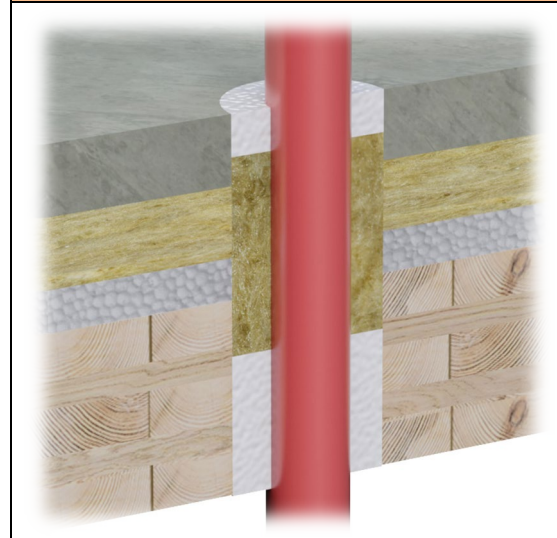

General rules: For single pipes, the distance between the pipe and the edge of the sealant must be ≥ 30 mm. See distance a1: Fig 1.

Fig 1.

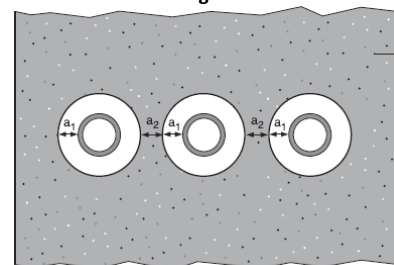

Construction of floor slab from bottom to top:

- CLT 140 thickness ≥ 140 mm.
- Thermal insulation of 30 mm thick combustible EPS, also called expanded polystyrene.
- Sound attenuation panel of 50 mm thick mineral wool, density ≥ 90 kg/m³.
- 50 mm thick cement screed, cement-based levelling compound or concrete. Total floor slab thickness ≥ 270 mm.

Table 46: CLT floor slab ≥ 140 mm with screed. Total floor slab thickness ≥ 270 mm		
Cast iron pipe (d) $\leq \varnothing 110$ mm, (t) 3.5 mm. C/U.	Fire resistance class	See detail, figure:
Cast iron pipe (d) $\leq \varnothing 110$ mm, (t) 3.5 mm. C/U. Opening in floor slab d: $\varnothing 170$ mm. Double-sided fire sealing using FIRESAFE GPG MORTAR. Installed on the exposed or unexposed side.	E 90 – EI 90	Figure 46

Installation, Figure 46

- Remove any debris and dust from the opening.
- Moisten absorbent materials with water or primer.
- GPG is mixed to a firm consistency with 4 parts GPG and 1 part water, or to a fluid consistency when using plasterboard on the underside of the floor slab.
- Seal the opening around the pipe with FIRESAFE GPG MORTAR to a depth of 100 mm in underside of the CLT floor slab.
- Fill the opening between the pipe and the edge of the sealant with loose mineral wool, density ≥ 50 kg/m³.
- Seal the opening between the pipe and the edge of the sealant with FIRESAFE GPG MORTAR to a depth of 30 mm on the top side of the cement floor slab. FIRESAFE GPG MORTAR can also be used as a fire seal in the opening in the floor slab without mineral wool infill.
- Before applying the fire sealing, standard plasterboard (12.5 mm) can be fixed to the underside of the floor slab.
- The plasterboard does not need to be removed after using GPG MORTAR to create a fire seal.

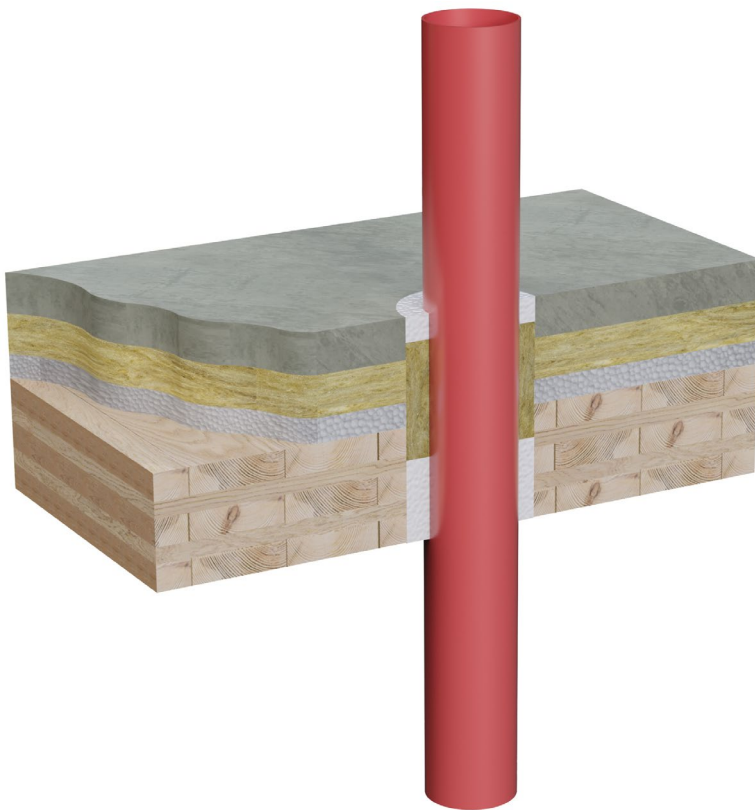

Note: Apply FIRESAFE GPG MORTAR around the pipe. Fire Sealing width 30 mm x 100 mm depth on the underside of the CLT floor slab. Fire sealing width 30 mm x 30 mm depth on the topside of the CLT floor slab.

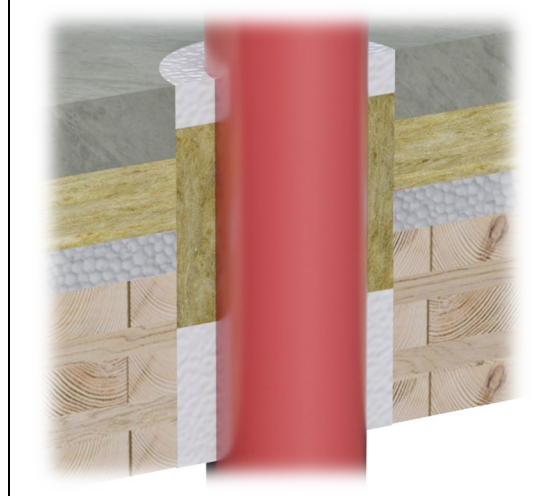

General rules: For single pipes, the distance between the pipe and the edge of the sealant must be ≥ 30 mm. See distance a1: Fig 1.

Fig 1.

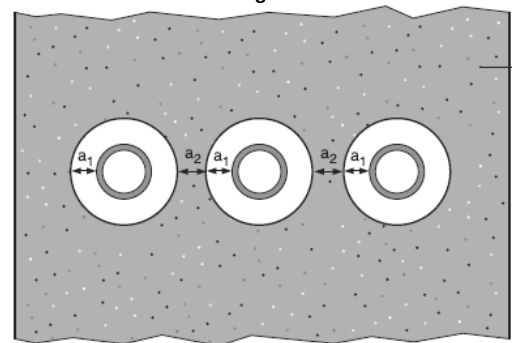

Construction of floor slab from bottom to top:

- CLT 140 thickness ≥ 140 mm.
- Thermal insulation of 30 mm thick combustible EPS, also called expanded polystyrene.
- Sound attenuation panel of 50 mm thick mineral wool, density ≥ 90 kg/m³.
- 50 mm thick cement screed, cement-based levelling compound or concrete. Total floor slab thickness ≥ 270 mm.

Table 47: CLT floor slab ≥ 140 mm with screed. Total floor slab thickness ≥ 270 mm

Floor drain type: PURUS Joti KS (cast iron). Cast iron drain pipe (d) $\leq \varnothing 75$ mm, (t) 3.5 mm. C/C.	Fire resistance class	See detail, figure:
Floor drain type PURUS Joti KS (cast iron). Cast iron drain pipe (d) $\leq \varnothing 75$ mm, (t) 3.5 mm. C/C. Opening in floor slab d: $\varnothing 175$ mm. One-sided fire sealing with FIRESAFE GPG MORTAR applied on the exposed side.	E 90 – EI 90	Figure 47

Installation, Figure 47

- A standard plasterboard (12.5 mm) can be fixed to the underside of the CLT floor slab.
 - Use a hollow drill bit or saw to make a hole in the plasterboard to fit the drain pipe.
 - After running the drain pipe through the plasterboard, remove any debris and dust in the opening and mix GPG MORTAR to a fluid consistency.
 - Fill the entire aperture in the CLT with GPG MORTAR. Fire sealing width 50 mm x 140 mm depth around the drain pipe.
- The fire sealing is then finished and the CLT floor slab is ready for further work by other trades.
- Lay thermal insulation of EPS/expanded polystyrene on top of the CLT floor slab. The thermal insulation of EPS/expanded polystyrene can be placed right up to the cast iron drain.
 - Lay mineral wool sound attenuation panels on top of the EPS/expanded polystyrene. The mineral wool sound attenuation panels can be placed right up to the cast iron drain.
 - Lay cement screed, cement-based screed or concrete on top of the mineral wool sound attenuation panels.
- The plasterboard does not need to be removed after using GPG MORTAR to create a fire seal.



Construction of floor slab from bottom to top:

- CLT 140 thickness ≥ 140 mm.
- Thermal insulation of 30 mm thick combustible EPS, also called expanded polystyrene.
- Sound attenuation panel of 50 mm thick mineral wool, density ≥ 90 kg/m³.
- 50 mm thick cement screed, cement-based levelling compound or concrete. Total floor slab thickness ≥ 270 mm.

Note: Apply FIRESAFE GPG MORTAR around drain pipes. Fire sealing width 50 mm x 140 mm depth on the underside of the CLT floor slab.

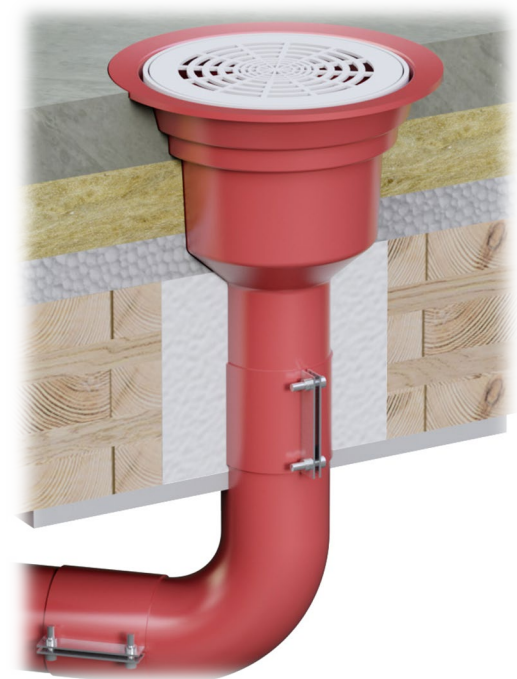
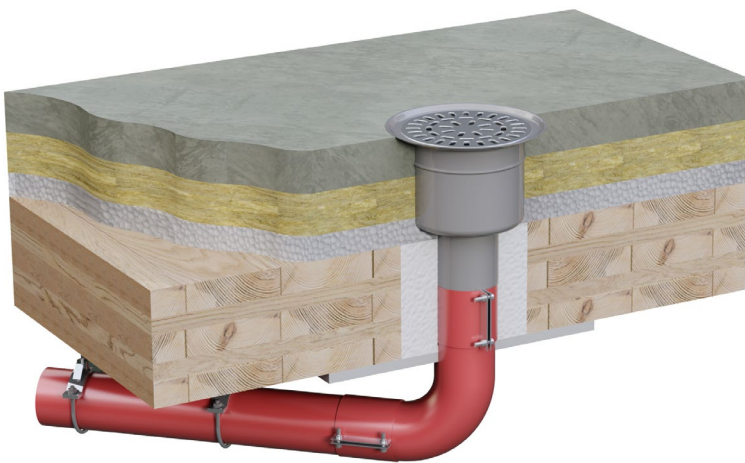

Table 48: CLT floor slab ≥ 140 mm with screed. Total floor slab thickness ≥ 270 mm		
Floor drain type: PURUS Joti Balder 75 R (stainless steel). Cast iron drain pipe (d) $\leq \varnothing 75$ mm, (t) 3.5 mm. C/C.	Fire resistance class	See detail, figure:
Floor drain type PURUS Joti Balder 75 R (stainless steel). Cast iron drain pipe (d) $\leq \varnothing 75$ mm (t) 3.5 mm. C/C. Opening in floor slab d: $\varnothing 175$ mm. One-sided fire sealing with FIRESAFE GPG MORTAR applied on the exposed side.	E 90 – EI 90	Figure 48

Installation, Figure 48

- A standard plasterboard (12.5 mm) can be fixed to the underside of the CLT floor slab.
 - Use a hollow drill bit or saw to make a hole in the plasterboard to fit the drain pipe.
 - After running the drain pipe through the plasterboard, remove any debris and dust in the opening and mix GPG MORTAR to a fluid consistency.
 - Fill the entire aperture in the CLT with GPG MORTAR. Fire sealing width 50 mm x 140 mm depth around the drain pipe.
- The fire sealing is then finished and the CLT floor slab is ready for further work by other trades.
- Lay thermal insulation of EPS/ expanded polystyrene on top of the CLT floor slab. The thermal insulation of EPS/ expanded polystyrene can be placed right up to the stainless steel drain.
 - Lay mineral wool sound attenuation panels on top of the EPS/ expanded polystyrene. The mineral wool sound attenuation panels can be placed right up to the stainless steel drain.
 - Lay cement screed, cement-based screed or concrete on top of the mineral wool sound attenuation panels.
- The plasterboard does not need to be removed after using GPG MORTAR to create a fire seal.



Construction of floor slab from bottom to top:

- CLT 140 thickness ≥ 140 mm.
- Thermal insulation of 30 mm thick combustible EPS, also called polystyrene.
- Sound attenuation panel of 50 mm thick mineral wool, density ≥ 90 kg/m³.
- 50 mm thick cement screed, cement-based levelling compound or concrete. Total floor slab thickness ≥ 270 mm.

Note: Apply FIRESAFE GPG MORTAR around drain pipes. Fire sealing width 50 mm x 140 mm depth on the underside of the CLT floor slab.

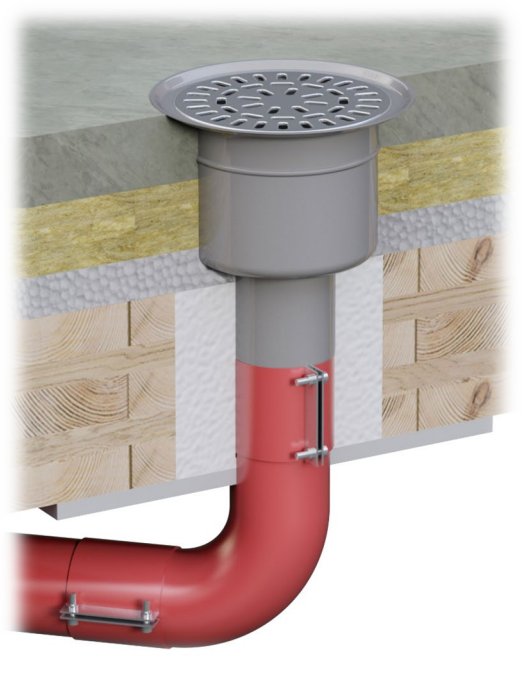

Table 49: CLT floor slab ≥ 140 mm with screed. Total floor slab thickness ≥ 270 mm

Floor drain type: PURUS Joti K (PP plastic). PP plastic drain pipe (d) $\leq \varnothing 75$ mm, (t) 2.6 mm. C/C.	Fire resistance class	See detail, figure:
Floor drain type: PURUS Joti K (PP plastic). PP plastic drain pipe with connecting sleeve (d) $\leq \varnothing 75$ mm, (t) 2.6 mm. C/C. Opening in floor slab d: $\varnothing 175$ mm. One-sided fire sealing with GPG and a FIRESAFE FIRE COLLAR installed on the exposed side.	E 90 – EI 90	Figure 49

Installation, Figure 49

- A standard plasterboard (12.5 mm) can be fixed to the underside of the CLT floor slab.
- Use a hollow drill bit or saw to make a hole in the plasterboard to fit the drain pipe.
- After running the drain pipe through the plasterboard, remove any debris and dust in the opening and mix GPG MORTAR to a fluid consistency.
- Fill the entire aperture in the CLT with GPG MORTAR. Fire sealing width 50 mm x 100 mm depth around the drain pipe.
- Install a FIRESAFE FIRE COLLAR on the underside of the plasterboard.
- Attach the FIRE COLLAR with four wood screws, which are screwed into the GPG fire sealing. Size M 5–6. Length 60–80 mm.

- The fire sealing is then finished and the CLT floor slab is ready for further work by other trades.

- Lay thermal insulation of EPS/polystyrene on top of the CLT floor slab. The thermal insulation of EPS/ expanded polystyrene can be placed right up to the plastic drain.
- Lay mineral wool sound attenuation panels on top of the EPS/expanded polystyrene. The mineral wool sound attenuation panels can be placed right up to the plastic drain.
- Lay cement screed, cement-based screed or concrete on top of the mineral wool sound attenuation panels.

- The plasterboard must not be removed after using GPG MORTAR to create a fire sealing and after installation of the FIRESAFE FIRE COLLAR.



Construction of floor slab from bottom to top:

- CLT 140 thickness ≥ 140 mm.
- Thermal insulation of 30 mm thick combustible EPS, also called expanded polystyrene.
- Sound attenuation panel of 50 mm thick mineral wool, density ≥ 90 kg/m³.
- 50 mm thick cement screed, cement-based levelling compound or concrete. Total floor slab thickness ≥ 270 mm.

Note: Apply FIRESAFE GPG MORTAR around drain pipes. Fire sealing width 50 mm x 100 mm depth on the underside of the CLT floor slab. Install a FIRESAFE FIRE COLLAR around the plastic pipe on the underside of the plasterboard.

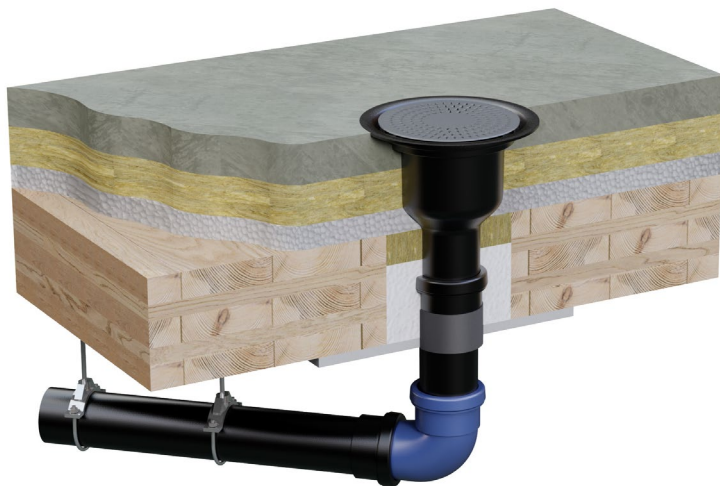

Table 50: CLT floor slab ≥ 140 mm with screed. Total floor slab thickness ≥ 270 mm

Floor drain type: PURUS Joti K (PP plastic). PP plastic drain pipe (d) $\leq \varnothing 75$ mm, (t) 2.6 mm. C/C.	Fire resistance class	See detail, figure:
Floor drain type: PURUS Joti K (PP plastic). PP plastic drain pipe with connecting sleeve (d) $\leq \varnothing 75$ mm, (t) 2.6 mm. C/C. Opening in floor slab d: $\varnothing 175$ mm. One-sided Fire Stopping using GPG and FIRESAFE FIRE WRAP installed on the exposed side.	E 90 – EI 90	Figure 50

Installation, Figure 50

- A standard plasterboard (12.5 mm) can be fixed to the underside of the CLT floor slab.
 - Use a hollow drill bit or saw to make a hole in the plasterboard to fit the drain pipe with or without a connecting sleeve and FIRESAFE FIRE WRAP.
 - After running the drain pipe through the plasterboard, apply two layers of 2 mm thick FIRESAFE FIRE WRAP around the plastic pipes with connecting sleeve.
(FIRE WRAP must be installed down the hole in the plasterboard, and must be visible from the underside of the floor slab after installation).
 - After running the drain pipe through the plasterboard, remove any debris and dust in the opening and mix GPG MORTAR to a fluid consistency.
 - Fill the entire aperture in the CLT with GPG MORTAR. Fire Stopping width 50 mm x 100 mm depth around the drain pipe.
- The fire sealing is then finished and the CLT floor slab is ready for further work by other trades.
- Lay thermal insulation of EPS/ expanded polystyrene on top of the CLT floor slab. The thermal insulation of EPS/expanded polystyrene can be placed right up to the plastic drain.
 - Lay mineral wool sound attenuation panels on top of the EPS/expanded polystyrene. The mineral wool sound attenuation panels can be placed right up to the plastic drain.
 - Lay cement screed, cement-based screed or concrete on top of the mineral wool sound attenuation panels.
- The plasterboard must not be removed after using GPG MORTAR to create a fire sealing and after installation of FIRESAFE FIRE WRAP.



Construction of floor slab from bottom to top:

- CLT 140 thickness ≥ 140 mm.
- Thermal insulation of 30 mm thick combustible EPS, also called polystyrene.
- Sound attenuation panel of 50 mm thick mineral wool, density ≥ 90 kg/m³.
- 50 mm thick cement screed, cement-based levelling compound or concrete. Total floor slab thickness ≥ 270 mm.

Note: Apply FIRESAFE FIRE WRAP around the drain pipe and down into the plasterboard. Apply GPG MORTAR in fire sealing width 50 mm x 100 mm depth in the CLT floor slab.



Table 51: CLT floor slab \geq 140 mm.		
PP-MD plastic pipe (d) \leq \varnothing 110 mm, (t) 3.8 mm. U/C.	Fire resistance class	See detail, figure:
PP-MD plastic pipe (d) \leq \varnothing 110 mm, (t) 3.8 mm. U/C. Opening in floor slab d: \varnothing 150 mm. One-sided fire sealing using GPG and FIRESAFE FIRE WRAP installed on the exposed side.	E 90 – EI 90	Figure 51

Installation, Figure 51

- A standard plasterboard (12.5 mm) can be fixed to the underside of the CLT floor slab.
 - Use a hollow drill bit or saw to make a hole in the plasterboard to fit the plastic pipe and FIRESAFE FIRE WRAP.
 - After running the drain pipe through the plasterboard, apply two layers of 2 mm thick FIRESAFE FIRE WRAP around the plastic pipes with connecting sleeve.
(FIRE WRAP must be installed down the hole in the plasterboard, and must be visible from the underside of the floor slab after installation).
 - After running the drain pipe through the plasterboard, remove any debris and dust in the opening and mix GPG MORTAR to a fluid consistency.
 - Fill the entire aperture in the CLT with GPG MORTAR. Fire sealing width 30 mm x 140 mm depth around the plastic pipe.
- The plasterboard must not be removed after using GPG MORTAR to create a fire sealing and after installation of FIRESAFE FIRE WRAP.



Note: Apply FIRESAFE FIRE WRAP around the drain pipe and down into the plasterboard. Apply GPG MORTAR in Fire sealing width 20 mm x 140 mm depth in the CLT floor slab.



INSTALLATION MANUAL

FIRE SEALING IN CLT CONSTRUCTIONS

Fire Stopping System Hand Book

FIRESAFE

Date: 19.11.2021

Prepared by: Pål Paulsen

Controlled by: Hallvard K Engøy

Rev.: 01

Table 52: CLT floor slab ≥ 140 mm.		
PP-MD plastic pipe (d) $\leq \varnothing 110$ mm at a 45° angle, (t) 3.8 mm. U/C.	Fire resistance class	See detail, figure:
PP-MD plastic pipe (d) $\leq \varnothing 110$ mm at a 45° angle, (t) 3.8 mm. U/C. Opening in floor slab d: $\varnothing 336$ mm. One-sided fire sealing using GPG and a FIRESAFE FIRE COLLAR $\varnothing 160$ installed on the exposed side.	E 90 – EI 90	Figure 52

Installation, Figure 52

- A standard plasterboard (12.5 mm) or other board can be fixed to the underside of the CLT floor slab.
 - Remove any debris and dust from the opening. Mix GPG MORTAR to a fluid consistency with 2 parts GPG and 1 part water.
 - Fill the entire aperture in the CLT with GPG MORTAR to a depth of 140 mm.
 - After installing the Fire Stopping, remove the plasterboard before installing the FIRESAFE FIRE COLLAR.
 - Install a FIRESAFE FIRE COLLAR (size $\varnothing 160$ mm) underneath the GPG fire sealing.
 - Fit the FIRESAFE FIRE COLLAR lengthwise on the pipe as shown in Fig 1.
 - Attach the COLLAR with four wood screws, which are screwed into the GPG fire sealing, or directly into the CLT floor slab. Size M 5–6. Length 60–80 mm.
- Only boards made of combustible material need to be removed.

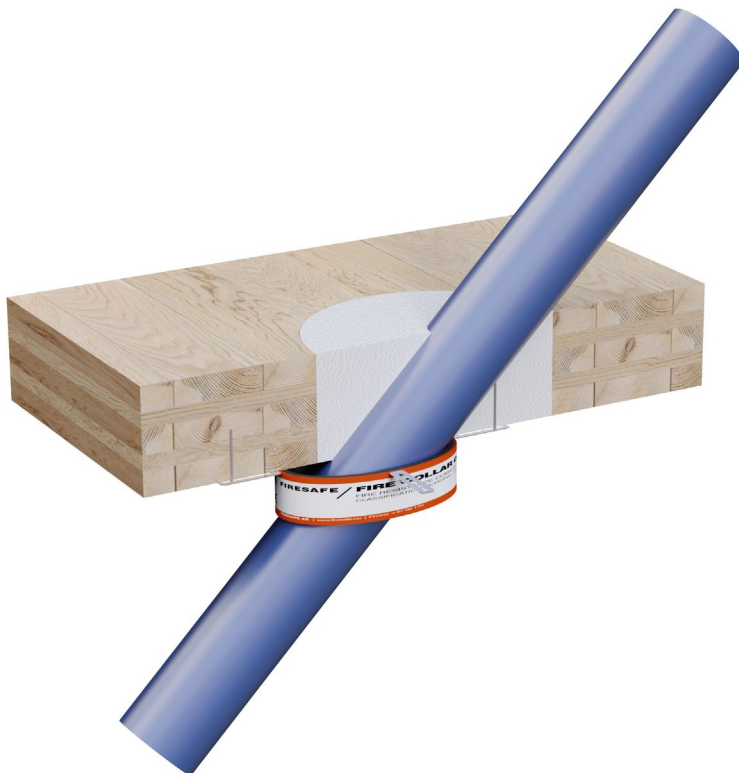

Note: Apply FIRESAFE GPG MORTAR around the plastic pipe to a depth of 140 mm. Install a FIRESAFE FIRE COLLAR around the plastic pipe on the underside of the fire sealing.

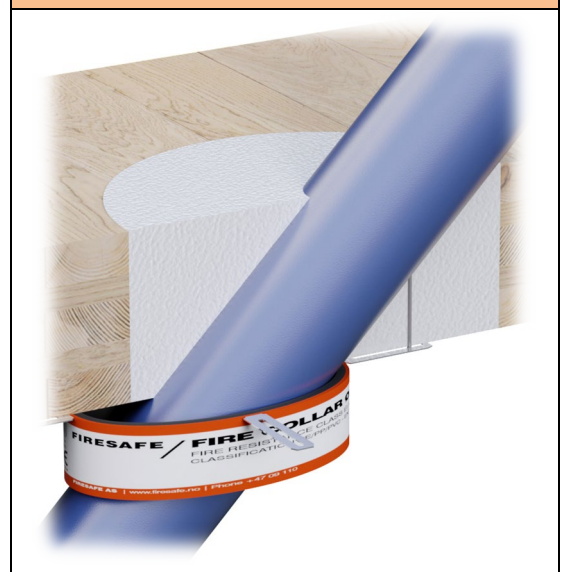

Fig 1.



FIRESAFE

All information in this data sheet is to be regarded as normative values obtained from tests and our collective knowledge and experience of the product. This data must not be used as a basis for or verification of other tests or systems. Firesafe AS accepts no liability for other use or misuse of the product. Users are responsible for ensuring they use the latest version of this document. Please check our website www.firesafe.no. This document may not be copied without the written consent of Firesafe AS.

Table 53: CLT floor slab ≥ 140 mm.		
PP-MD plastic pipe (d) $\leq \varnothing 110$ mm, (t) 3.8 mm. U/C.	Fire resistance class	See detail, figure:
PP-MD plastic pipe (d) $\leq \varnothing 110$ mm, (t) 3.8 mm. U/C. Opening in floor slab d: $\varnothing 150$ mm. One-sided fire sealing using GPG and a FIRESAFE FIRE COLLAR $\varnothing 110$ installed on the exposed side.	E 90 – EI 90	Figure 53

Installation, Figure 53

- A standard plasterboard (12.5 mm) can be fixed to the underside of the CLT floor slab.
- Remove any debris and dust from the opening. Mix GPG MORTAR to a fluid consistency with 2 parts GPG and 1 part water.
- Fill the entire aperture in the CLT with GPG MORTAR to a width of 20 mm x 140 mm depth.
- Install a FIRESAFE FIRE COLLAR (size $\varnothing 110$ mm) on the underside of the plasterboard and the GPG fire sealing.
- Attach the FIRE COLLAR with four wood screws, which are screwed into the GPG fire sealing, or directly into the CLT floor slab. Size M 5–6. Length 60–80 mm.

- The plasterboard must not be removed after using GPG MORTAR to create a fire sealing and after installation of the FIRESAFE FIRE COLLAR.



Note: Apply FIRESAFE GPG MORTAR around the plastic pipe in fire sealing width 20 mm x 140 mm depth. Install a FIRESAFE FIRE COLLAR around the plastic pipe on the underside of the fire sealing.



INSTALLATION MANUAL

FIRE SEALING IN CLT CONSTRUCTIONS

Fire Stopping System Hand Book

FIRESAFE

Date: 19.11.2021

Prepared by: Pål Paulsen

Controlled by: Hallvard K Engøy

Rev.: 01

FIRESAFE FIRE WRAP

PRODUCT DESCRIPTION

FIRESAFE Fire Wrap is a flexible strip for quick and easy installation in wall and floor structures.

FIRESAFE Fire Wrap contains heat-expanding graphite material. The graphite material in FIRESAFE Fire Wrap expands at a temperature of 180 °C to 18 times its original volume.

AREAS OF USE

FIRESAFE Fire Wrap is used as a Fire Stopping for plastic pipes, aluminium pipes and metal pipes in walls and floors, to form a secure fire sealing throughout the entire construction.

FIRESAFE Fire Wrap is available in 18 m rolls. Width 50 mm x thickness

1.8–2 mm. Or a single piece of Fire Wrap adapted to the exact diameter of the pipe.

Rolls of FIRESAFE Fire Wrap can be easily cut with scissors or a knife to fit the pipe.

FIRESAFE Fire Wrap can be installed in small, individual openings as penetration sealing in walls and floors combined with

FIRESAFE FT Acrylic, or installed in large openings combined with FIRESAFE FT Board or FIRESAFE GPG MORTAR.

Additional products/combo products should be selected in accordance with the type of installation, as shown in the installation instructions.

CERTIFICATION / FIRE RESISTANCE

- FIRESAFE FIRE WRAP has been tested in accordance with NS-EN 1366-3 (2009) and NS-EN 1366-4 (2009), as well as EN 13501-1/2.
- Certified in accordance with ETA 15/0039. FIRESAFE Fire Wrap.
- Fire resistance EI 30 to EI 120 with extensive areas of application for walls and floors.
- Fire-rated Plaster or masonry walls/precast structure (density 600–650 kg/m³) ≥ 100 mm.
- Fire-rated Masonry floor slabs/precast structure (density 600–650 kg/m³) ≥ 150 mm.
- Fire resistance class EI 90 in CLT structures (cross-laminated timber structures).
- Approved as a smoke seal in accordance with EN 1634-3.

INSTALLATION

- Clean pipes to remove grease and moisture. Remove any debris and dust in the opening.
- For uneven surfaces in apertures and small holes, first use FIRESAFE FT Acrylic to improve the effectiveness of smoke sealing.
- Always install FIRESAFE Fire Wrap on both sides of a wall and on one side (underside) of concrete floor slabs.
- FIRESAFE Fire Wrap must be fitted tightly around the pipe.
- Tape the FIRESAFE Fire Wrap around the pipe to keep it in place.
- Rolls of FIRESAFE Fire Wrap can be cut to the correct size for the desired number of layers, depending on the type and size of the pipe.
- Seal openings smaller than 15 mm between the structure and FIRESAFE Fire Wrap with FIRESAFE FT Acrylic.

ARTICLE / ARTICLE NAME / SIZE

- 104021: FIRESAFE Fire Wrap on an 18 m roll, packed in a cardboard box.

STORAGE/ SHELF LIFE

- Store in a dry place, between +5 °C and +30 °C. Best stored in a cool and dark place.
Shelf life of multiple years in unopened packaging.
- Should be protected from frost.

SAFETY

- FIRESAFE Fire Wrap is solvent free and environmentally friendly. Not known to be an irritant in the event of contact with skin, but avoid contact with eyes and mouth. See material safety data sheet for FIRESAFE Fire Wrap.



FIRESAFE

All information in this data sheet is to be regarded as normative values obtained from tests and our collective knowledge and experience of the product. This data must not be used as a basis for or verification of other tests or systems. Firesafe AS accepts no liability for other use or misuse of the product. Users are responsible for ensuring they use the latest version of this document. Please check our website www.firesafe.no. This document may not be copied without the written consent of Firesafe AS.

Table 54: CLT wall ≥ 100 mm.		
Cast iron pipe (d) $\leq \varnothing 110$ mm, (t) 3.5 mm. C/U.	Fire resistance class	See detail, figure:
Cast iron pipe (d) $\leq \varnothing 110$ mm, (t) 3.5 mm. 13 mm Armaflex AF. C/U. Opening in wall d: $\varnothing 154$ mm. Double-sided fire sealing with FIRESAFE FIRE WRAP installed on both sides of the wall.	E 90 – EI 60	Figure 54

Installation, Figure 54

- Remove any debris and dust from the opening.
- Moisten absorbent materials with water or primer.
- Apply two layers of 2 mm thick FIRESAFE FIRE WRAP around the pipe insulation, flush with the wall on both sides.
- Use FIRESAFE FT Acrylic to seal the opening between the CLT wall and FIRESAFE FIRE WRAP against smoke and fire.



Note: Apply two layers of FIRESAFE FIRE WRAP around the pipe insulation on both sides of the wall. Apply FIRESAFE FT Acrylic as a smoke seal.



*Pipes insulated with 13 mm cellular rubber of type Armaflex AF. Fire rating, Euroclass B/BL, s3-d0.

LS: Continuous pipe insulation, 13 mm thick, with 350 mm extending out on each side of the wall.

CS: The specified insulation must run the entire length of the pipe or a minimum of 800 mm, including in the penetration itself.

Table 55: CLT floor slab ≥ 140 mm.		
Cast iron pipe (d) $\leq \varnothing 110$ mm, (t) 3.5 mm. C/U.	Fire resistance class	See detail, figure:
Cast iron pipe (d) $\leq \varnothing 110$ mm, (t) 3.5 mm. 13 mm Armaflex AF. C/U. Opening in floor slab d: $\varnothing 146$ mm. One-sided fire sealing using FIRESAFE FIRE WRAP installed on the exposed side.	E 90 – EI 60	Figure 55

Installation, Figure 55

- Remove any debris and dust from the opening.
- Moisten absorbent materials with water or primer.
- Apply two layers of 2 mm thick FIRESAFE FIRE WRAP around the pipe insulation, flush with the underside of the CLT floor slab.
- Use FIRESAFE FT Acrylic to seal the opening between the CLT wall and FIRESAFE FIRE WRAP against smoke and fire.
- Seal the opening between the pipe, pipe insulation and edge of the fire sealing on the topside of the CLT floor slab against smoke and fire with FIRESAFE FT Acrylic.



Note: Apply two layers of FIRESAFE FIRE WRAP around the pipe insulation, flush with the underside of the floor slab. Apply FIRESAFE FT Acrylic as a smoke seal on both sides of the floor slab.



*Pipes insulated with 13 mm cellular rubber of type Armaflex AF. Fire rating, Euroclass B/BL, s3-d0.

LS: Continuous pipe insulation, 13 mm thick, with 350 mm extending out on each side of the floor slab.

CS: The specified insulation must run the entire length of the pipe or a minimum of 840 mm, including in the penetration itself.

Table 56: CLT floor slab \geq 140 mm.		
Cast iron pipe (d) \leq \varnothing 58 mm, (t) 3.5 mm. C/U.	Fire resistance class	See detail, figure:
Cast iron pipe (d) \leq \varnothing 58 mm, (t) 3.5 mm. 13 mm Armaflex AF. C/U. Opening in floor slab d: \varnothing 94 mm. One-sided fire sealing using FIRESAFE FIRE WRAP installed on the exposed side.	E 90 – EI 90	Figure 56

Installation, Figure 56

- Remove any debris and dust from the opening.
- Moisten absorbent materials with water or primer.
- Apply two layers of 2 mm thick FIRESAFE FIRE WRAP around the pipe insulation, flush with the underside of the CLT floor slab.
- Use FIRESAFE FT Acrylic to seal the opening between the CLT wall and FIRESAFE FIRE WRAP against smoke and fire.
- Seal the opening between the pipe, pipe insulation and edge of the fire sealing on the topside of the CLT floor slab against smoke and fire with FIRESAFE FT Acrylic.



Note: Apply two layers of FIRESAFE FIRE WRAP around the pipe insulation, flush with underside of the floor slab. Apply FIRESAFE FT Acrylic as a smoke seal on both sides of the floor slab.



*Pipes insulated with 13 mm cellular rubber of type Armaflex AF. Fire rating, Euroclass B/BL, s3-d0.

LS: Continuous pipe insulation, 13 mm thick, with 350 mm extending out on each side of the floor slab.

CS: The specified insulation must run the entire length of the pipe or a minimum of 840 mm, including in the penetration itself.

Table 57: CLT wall ≥ 100 mm.		
PE plastic pipe (d) $\leq \varnothing 110$ mm, (t) 3.4 mm. U/C.	Fire resistance class	See detail, figure:
PE plastic pipe (d) $\leq \varnothing 110$ mm, (t) 3.4 mm. U/C. Opening in wall d: $\varnothing 128$ mm. Double-sided fire sealing with FIRESAFE FIRE WRAP installed on both sides of the wall.	E 90 – EI 30	Figure 57

Installation, Figure 57

- Remove any debris and dust from the opening.
- Moisten absorbent materials with water or primer.
- Apply three layers of 2 mm thick FIRESAFE FIRE WRAP around the pipe, flush with the wall on both sides.
- Use FIRESAFE FT Acrylic to seal the opening between the CLT wall and FIRESAFE FIRE WRAP against smoke and fire.

Note: Apply three layers of FIRESAFE FIRE WRAP around the plastic pipe on both sides of the wall. Apply FIRESAFE FT Acrylic as a smoke seal between the Wrap and the edge of the fire sealing.



Table 58: CLT floor slab \geq 140 mm.		
PE plastic pipe (d) \leq \varnothing 110 mm, (t) 3.4 mm. U/C.	Fire resistance class	See detail, figure:
PE plastic pipe (d) \leq \varnothing 110 mm, (t) 3.4 mm. U/C. Opening in floor slab d: \varnothing 120 mm. One-sided fire sealing using FIRESAFE FIRE WRAP installed on the exposed side.	E 90 – EI 90	Figure 58

Installation, Figure 58

- Remove any debris and dust from the opening.
- Moisten absorbent materials with water or primer.
- Apply 2 x 2 layers of 2 mm thick FIRESAFE FIRE WRAP around the pipe, flush with the underside of the floor slab.
- Use FIRESAFE FT Acrylic to seal the opening between the CLT floor slab and FIRESAFE FIRE WRAP against smoke and fire.



Note: Apply two layers of FIRESAFE FIRE WRAP around the plastic pipe, flush with the underside of the floor slab. Apply FIRESAFE FT Acrylic around the pipe as a smoke seal on both sides of the floor slab.



Table 59: CLT wall \geq 100 mm.		
PE plastic pipe (d) \leq \varnothing 110 mm, (t) 10 mm. U/C.	Fire resistance class	See detail, figure:
PE plastic pipe (d) \leq \varnothing 110 mm, (t) 10 mm. U/C. Opening in wall d: \varnothing 128 mm. Double-sided fire sealing with FIRESAFE FIRE WRAP installed on both sides of the wall.	E 90 – EI 30	Figure 59

Installation, Figure 59

- Remove any debris and dust from the opening.
- Moisten absorbent materials with water or primer.
- Apply three layers of 2 mm thick FIRESAFE FIRE WRAP around the pipe, flush with the wall on both sides.
- Use FIRESAFE FT Acrylic to seal the opening between the CLT wall and FIRESAFE FIRE WRAP against smoke and fire.

Note: Apply three layers of FIRESAFE FIRE WRAP around the plastic pipe on both sides of the wall. Apply FIRESAFE FT Acrylic as a smoke seal between the Wrap and the edge of the fire sealing.



Table 60: CLT floor slab \geq 140 mm.		
PE plastic pipe (d) \leq \varnothing 110 mm, (t) 10 mm. U/C.	Fire resistance class	See detail, figure:
PE plastic pipe (d) \leq \varnothing 110 mm, (t) 10 mm. U/C. Opening in floor slab d: \varnothing 120 mm. One-sided fire sealing using FIRESAFE FIRE WRAP installed on the exposed side.	E 90 – EI 90	Figure 60

Installation, Figure 60

- Remove any debris and dust from the opening.
- Moisten absorbent materials with water or primer.
- Apply 2 x 2 layers of 2 mm thick FIRESAFE FIRE WRAP around the pipe, flush with the underside of the floor slab.
- Use FIRESAFE FT Acrylic to seal the opening between the CLT floor slab and FIRESAFE FIRE WRAP against smoke and fire.



Note: Apply 2 x 2 layers of FIRESAFE FIRE WRAP around the plastic pipe, flush with the underside of the floor slab. Apply FIRESAFE FT Acrylic around the pipe as a smoke seal on both sides of the floor slab.



Table 61: CLT wall ≥ 100 mm.		
PP plastic pipe (d) $\leq \varnothing 110$ mm, (t) 2.7 mm. U/C.	Fire resistance class	See detail, figure:
PP plastic pipe (d) $\leq \varnothing 110$ mm, (t) 2.7 mm. U/C. Opening in wall d: $\varnothing 128$ mm. Double-sided fire sealing with FIRESAFE FIRE WRAP installed on both sides of the wall.	E 90 – EI 60	Figure 61

Installation, Figure 61

- Remove any debris and dust from the opening.
- Moisten absorbent materials with water or primer.
- Apply three layers of 2 mm thick FIRESAFE FIRE WRAP around the pipe, flush with the wall on both sides.
- Use FIRESAFE FT Acrylic to seal the opening between the CLT wall and FIRESAFE FIRE WRAP against smoke and fire.

Note: Apply three layers of FIRESAFE FIRE WRAP around the plastic pipe on both sides of the wall. Apply FIRESAFE FT Acrylic as a smoke seal between the Wrap and the edge of the fire sealing.

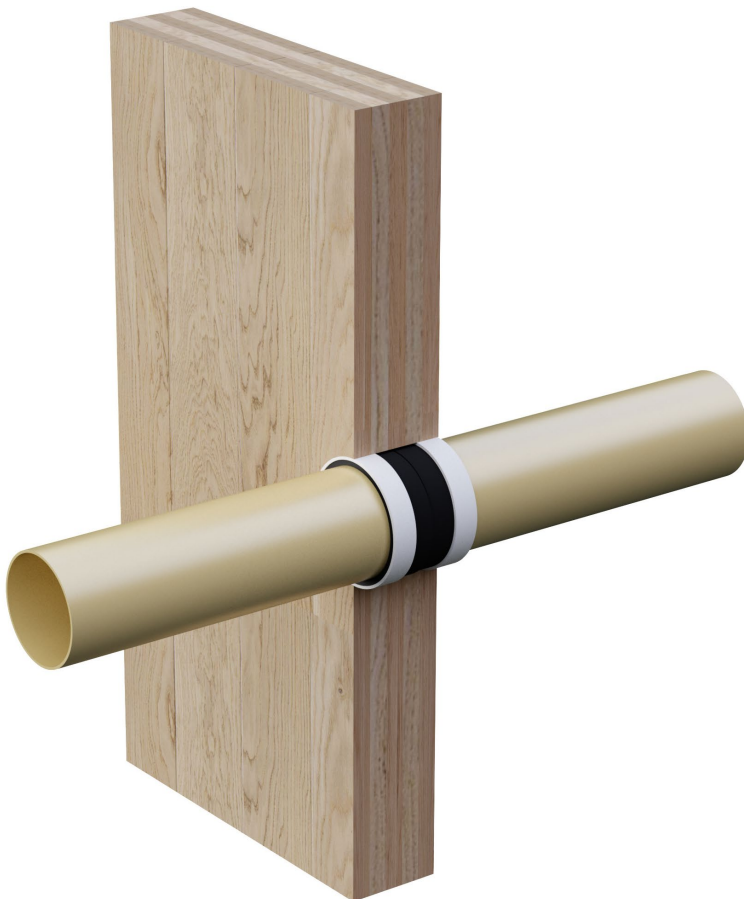

Table 62: CLT floor slab \geq 140 mm.		
PP plastic pipe (d) \leq \varnothing 110 mm, (t) 2.7 mm. U/C.	Fire resistance class	See detail, figure:
PP plastic pipe (d) \leq \varnothing 110 mm, (t) 2.7 mm. U/C. Opening in floor slab d: \varnothing 120 mm. One-sided fire sealing using FIRESAFE FIRE WRAP installed on the exposed side.	E 90 – EI 90	Figure 62

Installation, Figure 62

- Remove any debris and dust from the opening.
- Moisten absorbent materials with water or primer.
- Apply 2 x 2 layers of 2 mm thick FIRESAFE FIRE WRAP around the pipe, flush with the underside of the floor slab.
- Use FIRESAFE FT Acrylic to seal the opening between the CLT floor slab and FIRESAFE FIRE WRAP against smoke and fire.



Note: Apply 2 x 2 layers of FIRESAFE FIRE WRAP around the plastic pipe, flush with the underside of the floor slab. Apply FIRESAFE FT Acrylic around the pipe as a smoke seal on both sides of the floor slab.



Table 63: CLT wall ≥ 100 mm.		
PP plastic pipe (d) $\leq \varnothing 110$ mm, (t) 6.3 mm. U/C.	Fire resistance class	See detail, figure:
PP plastic pipe (d) $\leq \varnothing 110$ mm, (t) 6.3 mm. U/C. Opening in wall d: $\varnothing 128$ mm. Double-sided fire sealing with FIRESAFE FIRE WRAP installed on both sides of the wall.	E 90 – EI 90	Figure 63

Installation, Figure 63

- Remove any debris and dust from the opening.
- Moisten absorbent materials with water or primer.
- Apply three layers of 2 mm thick FIRESAFE FIRE WRAP around the pipe, flush with the wall on both sides.
- Use FIRESAFE FT Acrylic to seal the opening between the CLT wall and FIRESAFE FIRE WRAP against smoke and fire.

Note: Apply three layers of FIRESAFE FIRE WRAP around the plastic pipe on both sides of the wall. Apply FIRESAFE FT Acrylic as a smoke seal between the Wrap and the edge of the fire sealing.

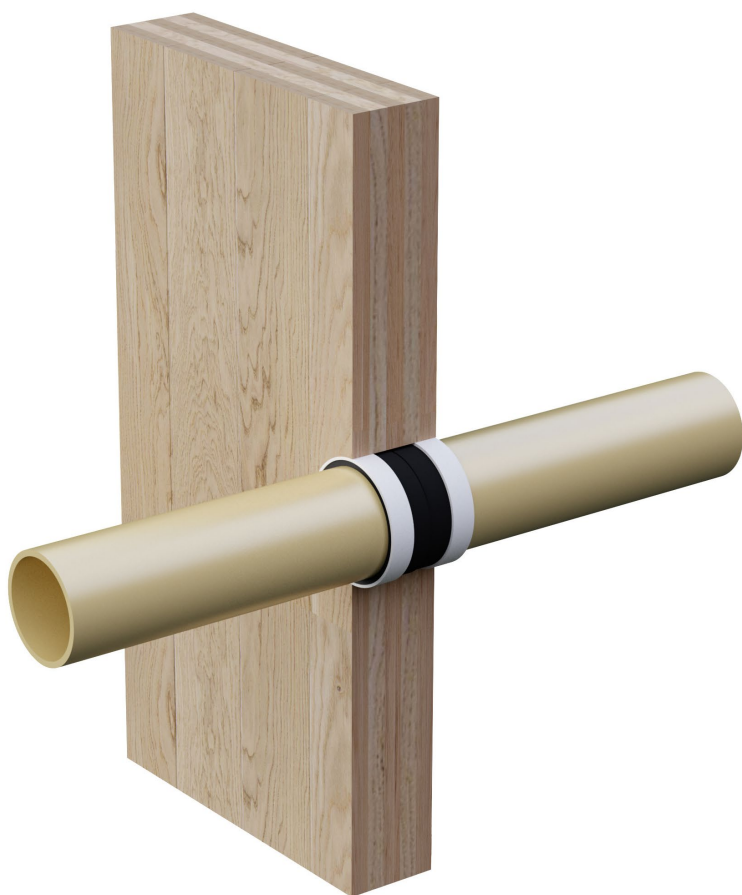
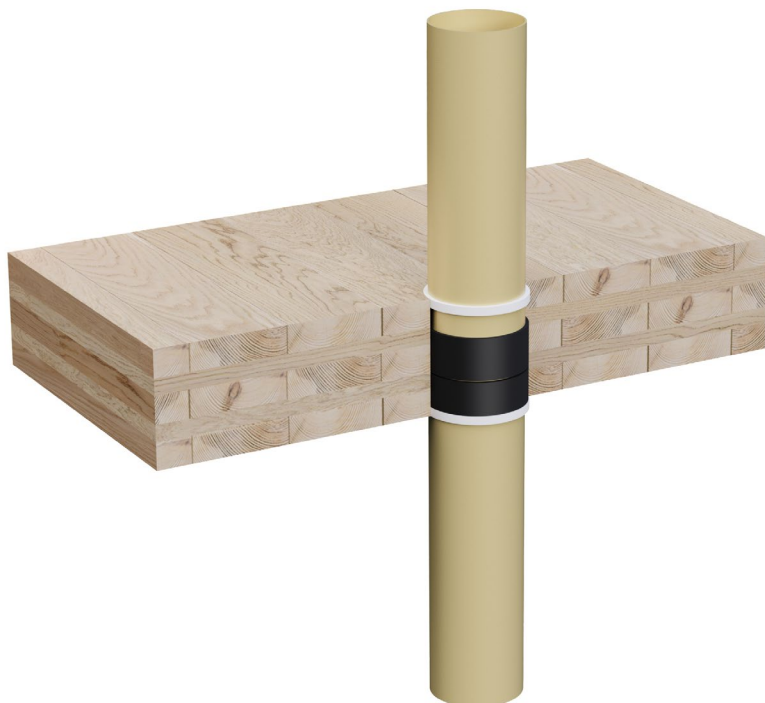

Table 64: CLT floor slab ≥ 140 mm.		
PP plastic pipe (d) $\leq \varnothing 110$ mm, (t) 6.3 mm. U/C.	Fire resistance class	See detail, figure:
PP plastic pipe (d) $\leq \varnothing 110$ mm, (t) 6.3 mm. U/C. Opening in floor slab d: $\varnothing 120$ mm. One-sided fire sealing using FIRESAFE FIRE WRAP installed on the exposed side.	E 90 – EI 90	Figure 64

Installation, Figure 64

- Remove any debris and dust from the opening.
- Moisten absorbent materials with water or primer.
- Apply 2 x 2 layers of 2 mm thick FIRESAFE FIRE WRAP around the pipe, flush with the underside of the floor slab.
- Use FIRESAFE FT Acrylic to seal the opening between the CLT floor slab and FIRESAFE FIRE WRAP against smoke and fire.



Note: Apply 2 x 2 layers of FIRESAFE FIRE WRAP around the plastic pipe, flush with the underside of the floor slab. Apply FIRESAFE FT Acrylic around the pipe as a smoke seal on both sides of the floor slab.



Table 65: CLT floor slab \geq 140 mm.		
Aluminium pipe PE-X (d) \leq \varnothing 16 mm, (t) 2.25 mm. U/C.	Fire resistance class	See detail, figure:
Alu PE-X (d) \leq \varnothing 16 mm, (t) 2.25. 13 mm Armaflex AF. U/C. Opening in floor slab d: \varnothing 52 mm. One-sided fire sealing using FIRESAFE FIRE WRAP installed on the exposed side.	E 90 – EI 90	Figure 65

Installation, Figure 65

- Remove any debris and dust from the opening.
- Moisten absorbent materials with water or primer.
- Apply two layers of 2 mm thick FIRESAFE FIRE WRAP around the pipe insulation, flush with the underside of the floor slab.
- Use FIRESAFE FT Acrylic to seal the opening between the CLT floor slab and FIRESAFE FIRE WRAP against smoke and fire.



Note: Apply two layers of FIRESAFE FIRE WRAP around the pipe insulation, flush with the underside of the floor slab. Apply FIRESAFE FT Acrylic around the pipe insulation as a smoke seal on both sides of the floor slab.



*Pipes insulated with 13 mm cellular rubber of type Armaflex AF. Fire rating, Euroclass B/BL, s3-d0.

LS: Continuous pipe insulation, 13 mm thick, with 350 mm extending out on each side of the floor slab.

CS: The specified insulation must run the entire length of the pipe or a minimum of 850 mm, including in the penetration itself.

Table 66: CLT floor slab \geq 140 mm.		
Aluminium pipe PE-X (d) \leq \varnothing 63 mm, (t) 4.5 mm. U/C.	Fire resistance class	See detail, figure:
Alu PE-X (d) \leq \varnothing 63 mm, (t) 4.5. 13 mm Armaflex AF. U/C. Opening in floor slab d: \varnothing 99 mm. One-sided fire sealing using FIRESAFE FIRE WRAP installed on the exposed side.	E 90 – EI 90	Figure 66

Installation, Figure 66

- Remove any debris and dust from the opening.
- Moisten absorbent materials with water or primer.
- Apply two layers of 2 mm thick FIRESAFE FIRE WRAP around the pipe insulation, flush with the underside of the floor slab.
- Use FIRESAFE FT Acrylic to seal the opening between the CLT floor slab and FIRESAFE FIRE WRAP against smoke and fire.



Note: Apply two layers of FIRESAFE FIRE WRAP around the pipe insulation, flush with the underside of the floor slab. Apply FIRESAFE FT Acrylic around the pipe insulation as a smoke seal on both sides of the floor slab.



*Pipes insulated with 13 mm cellular rubber of type Armaflex AF. Fire rating, Euroclass B/BL, s3-d0.

LS: Continuous pipe insulation, 13 mm thick, with 350 mm extending out on each side of the floor slab.

CS: The specified insulation must run the entire length of the pipe or a minimum of 850 mm, including in the penetration itself.

Table 67: CLT floor slab \geq 140 mm.		
Steel pipe (d) \leq \varnothing 42 mm, (t) 2.6 mm. C/U.	Fire resistance class	See detail, figure:
Steel pipe (d) \leq \varnothing 42 mm. (t) 2.6 mm. 13 mm Armaflex AF. C/U. Opening in floor slab d: \varnothing 78 mm. One-sided fire sealing using FIRESAFE FIRE WRAP installed on the exposed side.	E 90 – EI 90	Figure 67

Installation, Figure 67

- Remove any debris and dust from the opening.
- Moisten absorbent materials with water or primer.
- Apply two layers of 2 mm thick FIRESAFE FIRE WRAP around the pipe insulation, flush with the underside of the floor slab.
- Use FIRESAFE FT Acrylic to seal the opening between the CLT floor slab and FIRESAFE FIRE WRAP against smoke and fire.



Note: Apply two layers of FIRESAFE FIRE WRAP around the pipe insulation, flush with the underside of the floor slab. Apply FIRESAFE FT Acrylic around the pipe insulation as a smoke seal on both sides of the floor slab.



*Pipes insulated with 13 mm cellular rubber of type Armaflex AF. Fire rating, Euroclass B/BL, s3-d0.

LS: Continuous pipe insulation, 13 mm thick, with 350 mm extending out on each side of the floor slab.

CS: The specified insulation must run the entire length of the pipe or a minimum of 850 mm, including in the penetration itself.

Table 68: CLT floor slab \geq 140 mm.		
Steel pipe (d) \leq \varnothing 89.9 mm, (t) 3.0 mm. C/U.	Fire resistance class	See detail, figure:
Steel pipe (d) \leq \varnothing 89.9 mm. (t) 3.0 mm. 13 mm Armaflex AF. C/U. Opening in floor slab d: \varnothing 126 mm. One-sided fire sealing using FIRESAFE FIRE WRAP installed on the exposed side.	E 90 – EI 90	Figure 68

Installation, Figure 68

- Remove any debris and dust from the opening.
- Moisten absorbent materials with water or primer.
- Apply two layers of 2 mm thick FIRESAFE FIRE WRAP around the pipe insulation, flush with the underside of the floor slab.
- Use FIRESAFE FT Acrylic to seal the opening between the CLT floor slab and FIRESAFE FIRE WRAP against smoke and fire.



Note: Apply two layers of FIRESAFE FIRE WRAP around the pipe insulation, flush with the underside of the floor slab. Apply FIRESAFE FT Acrylic around the pipe insulation as a smoke seal on both sides of the floor slab.

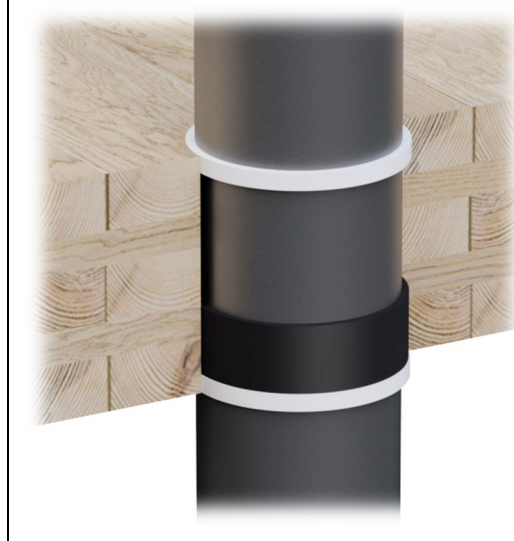

*Pipes insulated with 13 mm cellular rubber of type Armaflex AF. Fire rating, Euroclass B/BL, s3-d0.

LS: Continuous pipe insulation, 13 mm thick, with 350 mm extending out on each side of the floor slab.

CS: The specified insulation must run the entire length of the pipe or a minimum of 850 mm, including in the penetration itself.

Table 69: CLT floor slab ≥ 140 mm.		
Copper and steel pipes (d) $\leq \varnothing 12$ mm, (t) 1.0 mm. C/U.	Fire resistance class	See detail, figure:
Copper and steel pipes (d) $\leq \varnothing 12$ mm, (t) 1.0 mm. 13 mm Armaflex AF. C/U. Opening in floor slab d: $\varnothing 48$ mm. One-sided fire sealing using FIRESAFE FIRE WRAP installed on the exposed side.	E 90 – EI 90	Figure 69

Installation, Figure 69

- Remove any debris and dust from the opening.
- Moisten absorbent materials with water or primer.
- Apply two layers of 2 mm thick FIRESAFE FIRE WRAP around the pipe insulation, flush with the underside of the floor slab.
- Use FIRESAFE FT Acrylic to seal the opening between the CLT floor slab and FIRESAFE FIRE WRAP against smoke and fire.



Note: Apply two layers of FIRESAFE FIRE WRAP around the pipe insulation, flush with the underside of the floor slab. Apply FIRESAFE FT Acrylic around the pipe insulation as a smoke seal on both sides of the floor slab.



*Pipes insulated with 13 mm cellular rubber of type Armaflex AF. Fire rating, Euroclass B/BL, s3-d0.

LS: Continuous pipe insulation, 13 mm thick, with 350 mm extending out on each side of the floor slab.

CS: The specified insulation must run the entire length of the pipe or a minimum of 850 mm, including in the penetration itself.

Table 70: CLT floor slab \geq 140 mm.		
Copper and steel pipes (d) \leq \varnothing 76.1 mm, (t) 2.0 mm. C/U.	Fire resistance class	See detail, figure:
Copper and steel pipes (d) \leq \varnothing 76.1 mm, (t) 2.0 mm. 13 mm Armaflex AF. C/U. Opening in floor slab d: \varnothing 112 mm. One-sided fire sealing using FIRESAFE FIRE WRAP installed on the exposed side.	E 90 – EI 30	Figure 70

Installation, Figure 70

- Remove any debris and dust from the opening.
- Moisten absorbent materials with water or primer.
- Apply two layers of 2 mm thick FIRESAFE FIRE WRAP around the pipe insulation, flush with the underside of the floor slab.
- Use FIRESAFE FT Acrylic to seal the opening between the CLT floor slab and FIRESAFE FIRE WRAP against smoke and fire.



Note: Apply two layers of FIRESAFE FIRE WRAP around the pipe insulation, flush with the underside of the floor slab. Apply FIRESAFE FT Acrylic around the pipe insulation as a smoke seal on both sides of the floor slab.



*Pipes insulated with 13 mm cellular rubber of type Armaflex AF. Fire rating, Euroclass B/BL, s3-d0.

LS: Continuous pipe insulation, 13 mm thick, with 350 mm extending out on each side of the floor slab.

CS: The specified insulation must run the entire length of the pipe or a minimum of 850 mm, including in the penetration itself.

FIRESAFE FIRE COLLAR

PRODUCT DESCRIPTION

The FIRESAFE FIRE COLLAR consists of a metal frame of galvanised steel internally coated with a heat-expanding, graphite-based material.

The graphite material in the FIRESAFE FIRE COLLAR expands quickly at a temperature of about 180 °C, up to 18 times

its original volume and closes penetrations with combustible pipes in the event of fire.

AREAS OF USE

The FIRESAFE FIRE COLLAR is used on PE/PP/PVC plastic pipes $\leq \varnothing 400$ mm.

The FIRESAFE FIRE COLLAR is used on plastic pipes in walls and floors, to form a secure fire sealing in the entire structure.

FIRESAFE Fire Wrap can be installed in small openings as a simple fire sealing in combination with FIRESAFE FT Acrylic or installed in large openings combined with FIRESAFE FT Board or FIRESAFE GPG MORTAR.

CERTIFICATION / FIRE RESISTANCE

- The FIRESAFE FIRE COLLAR has been tested in accordance with NS-EN 1366-3 (2009) and EN 13501-1/2.
- Certified in accordance with ETA 15/0339.
- Fire resistance EI 30 to EI 180 with extensive areas of application for walls and floors.
- Fire-rated walls in accordance with EN 1363-1.: Plaster or masonry walls/precast structure (density 600–650 kg/m³) ≥ 100 mm.
- Fire-rated Masonry floor slabs/precast structure (density 600–650 kg/m³) ≥ 150 mm.
- Fire resistance class EI 90 in CLT structures (cross-laminated timber structures).

INSTALLATION

- Clean pipes to remove grease and moisture. Remove any debris and dust in the opening.
- Always install a FIRESAFE FIRE COLLAR on both sides of a wall and on one side (underside) of floor slabs.
- Seal openings smaller than 5 mm between the pipe and the structure with FIRESAFE FT Acrylic to ensure a smoke seal and fire sealing before installing a FIRESAFE COLLAR.
- When attaching a FIRESAFE COLLAR to a plasterboard wall, use plasterboard anchor screws that expand on the back of the plasterboard or other special plasterboard screws.
- When attaching a FIRESAFE COLLAR to concrete, use steel expansion bolts for the concrete.
- When attaching a FIRESAFE COLLAR to a CLT structure, use wood screws size M 5–6, length 60–80 mm.
- When attaching a FIRESAFE COLLAR to FIRESAFE GPG MORTAR, use wood screws size M 5–6, length 60–80 mm.
- A FIRESAFE COLLAR that is larger than the pipe diameter can be used on pipes that are installed at an angle in relation to the wall or floor slab.
- Fire sealing compound must not be applied between pipes and inside a FIRESAFE FIRE COLLAR.

ARTICLE / ARTICLE NAME / SIZE

- The FIRESAFE FIRE COLLAR is available in all sizes, adapted to the size of the pipe.

STORAGE/ SHELF LIFE

- Store in a dry place, between +5 °C and +30 °C. Best stored in a cool and dark place.
Shelf life of multiple years in unopened packaging.
- Should be protected from frost.

SAFETY

- The FIRESAFE FIRE COLLAR is solvent free and environmentally friendly. Not known to be an irritant in the event of contact with skin.
See separate material safety data sheet for the FIRESAFE FIRE COLLAR.



Table 71: CLT wall ≥ 100 mm.		
PE plastic pipe (d) $\leq \varnothing 110$ mm, (t) 3.4 mm. U/C.	Fire resistance class	See detail, figure:
PE plastic pipe (d) $\leq \varnothing 110$ mm, (t) 3.4 mm. U/C. Opening in wall d: $\varnothing 120$ mm. Double-sided fire sealing with a FIRESAFE FIRE COLLAR installed on both sides of the wall.	E 90 – EI 90	Figure 71

Installation, Figure 71

- Remove any debris and dust from the opening.
- Moisten absorbent materials with water or primer.
- Seal the opening between the pipe and the CLT wall on both sides against smoke and fire with FIRESAFE FT Acrylic before installing a FIRESAFE FIRE COLLAR.
- Install the FIRESAFE FIRE COLLAR around the plastic pipe on both sides of the wall. Attach the FIRESAFE FIRE COLLAR to the CLT wall with four wood screws.
Size M 5–6. Length 60–80 mm.



Note: Apply FIRESAFE FT Acrylic around the pipe as a smoke seal and fire sealing on both sides of the wall. Install a FIRE COLLAR around the pipe on both sides of the wall with four wood screws.



Table 72: CLT floor slab ≥ 140 mm.		
PE plastic pipe (d) $\leq \varnothing 110$ mm, (t) 3.4 mm. U/C.	Fire resistance class	See detail, figure:
PE plastic pipe (d) $\leq \varnothing 110$ mm, (t) 3.4 mm. U/C. Opening in floor slab d: $\varnothing 129$ mm. One-sided fire sealing using a FIRESAFE FIRE COLLAR installed on the exposed side.	E 90 – EI 90	Figure 72

Installation, Figure 72

- Remove any debris and dust from the opening.
- Moisten absorbent materials with water or primer.
- Install a FIRESAFE FIRE COLLAR, flush with the floor slab. A FIRESAFE FIRE COLLAR embedded in floor slabs is a specially tested solution for pipes where there is no space for an external installation, due to underlying pipe bends that would come close to the underside of the floor slab.
- Install a FIRESAFE FIRE COLLAR around the plastic pipe. Attach a FIRESAFE FIRE COLLAR to the CLT floor slab with four wood screws. Size M 5–6. Length 60–80 mm.
- Use FIRESAFE FT Acrylic to seal the opening between the CLT floor slab and the FIRESAFE FIRE COLLAR against smoke and fire.



Note: Install a FIRE COLLAR around the pipe on the underside of the floor slab with four wood screws. Apply FIRESAFE FT Acrylic around the pipe and a FIRE COLLAR as a smoke seal on both sides of the floor slab.

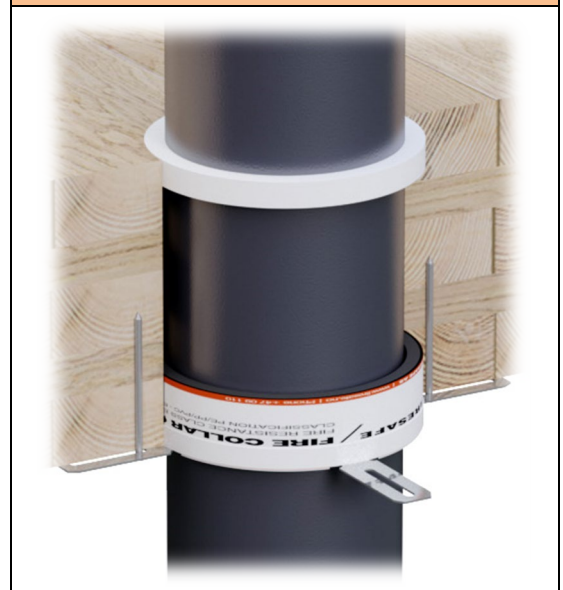

Table 73: CLT wall ≥ 100 mm.		
PE plastic pipe (d) $\leq \varnothing 110$ mm, (t) 10 mm. U/C.	Fire resistance class	See detail, figure:
PE plastic pipe (d) $\leq \varnothing 110$ mm, (t) 10 mm. U/C. Opening in wall d: $\varnothing 120$ mm. Double-sided fire sealing with a FIRESAFE FIRE COLLAR installed on both sides of the wall.	E 90 – EI 60	Figure 73

Installation, Figure 73

- Remove any debris and dust from the opening.
- Moisten absorbent materials with water or primer.
- Seal the opening between the pipe and the CLT wall on both sides against smoke and fire with FIRESAFE FT Acrylic before installing a FIRESAFE FIRE COLLAR.
- Install a FIRESAFE FIRE COLLAR around the plastic pipe on both sides of the wall. Attach a FIRESAFE FIRE COLLAR to the CLT wall with four wood screws. Size M 5–6. Length 60–80 mm.

Note: Apply FIRESAFE FT Acrylic around the pipe as a smoke seal and fire sealing on both sides of the wall. Install a FIRE COLLAR around the pipe on both sides of the wall with four wood screws.



Table 74: CLT floor slab \geq 140 mm.		
PE plastic pipe (d) \leq \varnothing 110 mm, (t) 10 mm. U/C.	Fire resistance class	See detail, figure:
PE plastic pipe (d) \leq \varnothing 110 mm, (t) 10 mm. U/C. Opening in floor slab d: \varnothing 129 mm. One-sided fire sealing using a FIRESAFE FIRE COLLAR installed on the exposed side.	E 90 – EI 90	Figure 74

Installation, Figure 74

- Remove any debris and dust from the opening.
- Moisten absorbent materials with water or primer.
- Install a FIRESAFE FIRE COLLAR, flush with the floor slab. A FIRESAFE FIRE COLLAR embedded in floor slabs is a specially tested solution for pipes where there is no space for an external installation, due to underlying pipe bends that would come close to the underside of the floor slab.
- Install a FIRESAFE FIRE COLLAR around the plastic pipe. Attach a FIRESAFE FIRE COLLAR to the CLT floor slab with four wood screws. Size M 5–6. Length 60–80 mm.
- Use FIRESAFE FT Acrylic to seal the opening between the CLT floor slab and the FIRESAFE FIRE COLLAR against smoke and fire.



Note: Install a FIRE COLLAR around the pipe on the underside of the floor slab with four wood screws. Apply FIRESAFE FT Acrylic around the pipe and the FIRE COLLAR as a smoke seal on both sides of the floor slab.

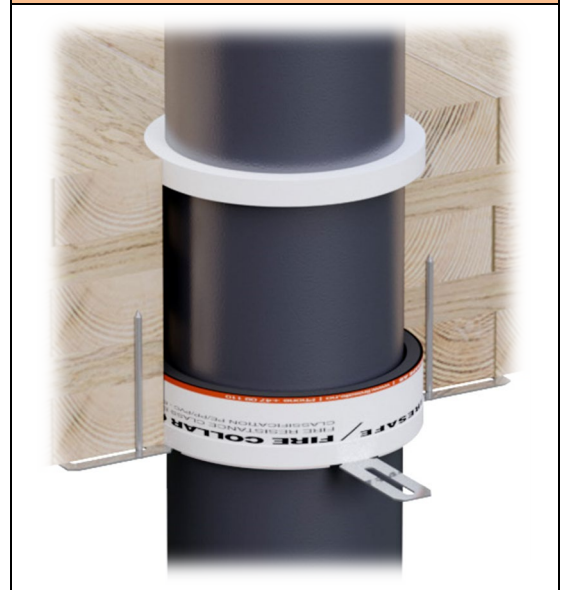
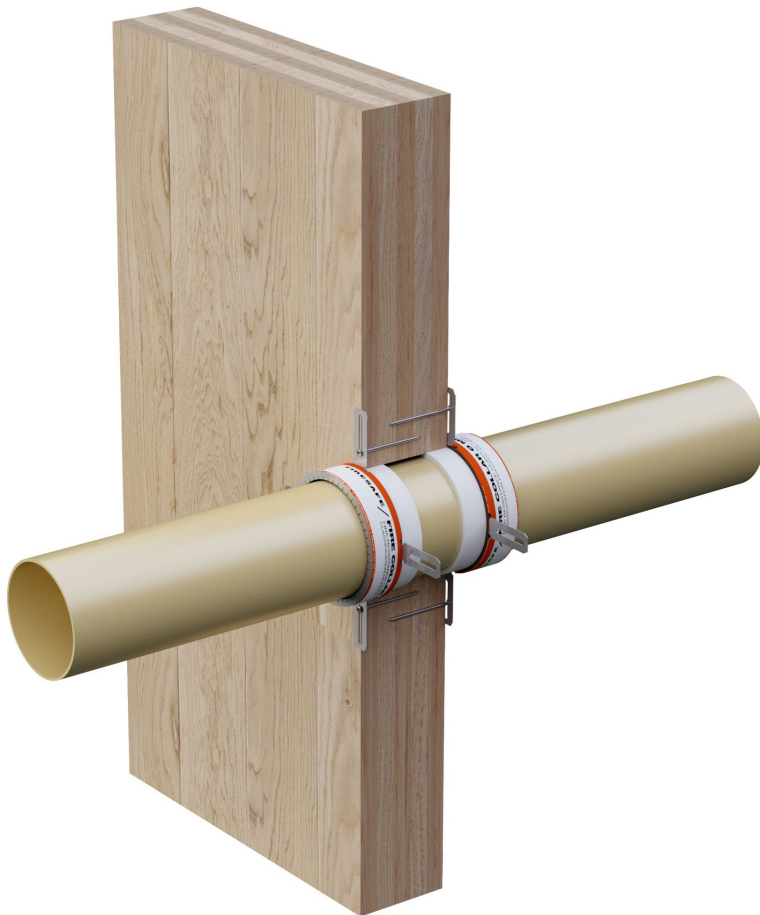

Table 75: CLT wall \geq 100 mm.		
PP plastic pipe (d) \leq \varnothing 110 mm, (t) 2.7 mm. U/C.	Fire resistance class	See detail, figure:
PP plastic pipe (d) \leq \varnothing 110 mm, (t) 2.7 mm. U/C. Opening in wall d: \varnothing 120 mm. Double-sided fire sealing with a FIRESAFE FIRE COLLAR installed on both sides of the wall.	E 90 – EI 90	Figure 75

Installation, Figure 75

- Remove any debris and dust from the opening.
- Moisten absorbent materials with water or primer.
- Seal the opening between the pipe and the CLT wall on both sides against smoke and fire with FIRESAFE FT Acrylic before installing a FIRESAFE FIRE COLLAR.
- Install a FIRESAFE FIRE COLLAR around the plastic pipe on both sides of the wall. Attach a FIRESAFE FIRE COLLAR to the CLT wall with four wood screws. Size M 5–6. Length 60–80 mm.



Note: Apply FIRESAFE FT Acrylic around the pipe as a smoke seal and Fire Stopping on both sides of the wall. Install a FIRE COLLAR around the pipe on both sides of the wall with four wood screws.



Table 76: CLT floor slab ≥ 140 mm.		
PP plastic pipe (d) $\leq \varnothing 110$ mm, (t) 2.7 mm. U/C.	Fire resistance class	See detail, figure:
PP plastic pipe (d) $\leq \varnothing 110$ mm, (t) 2.7 mm. U/C. Opening in floor slab d: $\varnothing 129$ mm. One-sided fire sealing using a FIRESAFE FIRE COLLAR installed on the exposed side.	E 90 – EI 90	Figure 76

Installation, Figure 76

- Remove any debris and dust from the opening.
- Moisten absorbent materials with water or primer.
- Install a FIRESAFE FIRE COLLAR, flush with the floor slab. A FIRESAFE FIRE COLLAR embedded in floor slabs is a specially tested solution for pipes where there is no space for an external installation, due to underlying pipe bends that would come close to the underside of the floor slab.
- Install a FIRESAFE FIRE COLLAR around the plastic pipe. Attach a FIRESAFE FIRE COLLAR to the CLT floor slab with four wood screws. Size M 5–6. Length 60–80 mm.
- Use FIRESAFE FT Acrylic to seal the opening between the CLT floor slab and a FIRESAFE FIRE COLLAR against smoke and fire.

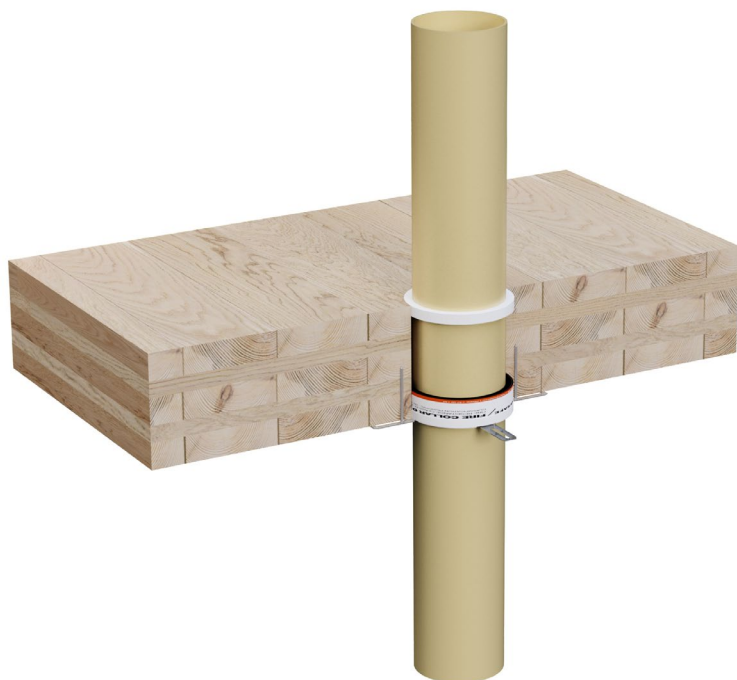

Note: Install a FIRE COLLAR around the pipe on the underside of the floor slab with four wood screws. Apply FIRESAFE FT Acrylic around the pipe and a FIRE COLLAR as a smoke seal on both sides of the floor slab.

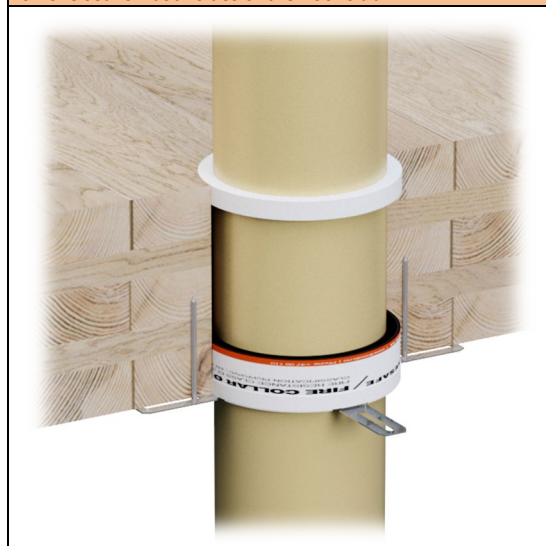

Table 77: CLT wall ≥ 100 mm.		
PP plastic pipe (d) $\leq \varnothing 110$ mm, (t) 6.3 mm. U/C.	Fire resistance class	See detail, figure:
PP plastic pipe (d) $\leq \varnothing 110$ mm, (t) 6.3 mm. U/C. Opening in wall d: $\varnothing 120$ mm. Double-sided fire sealing with a FIRESAFE FIRE COLLAR installed on both sides of the wall.	E 60 – EI 30	Figure 77

Installation, Figure 77

- Remove any debris and dust from the opening.
- Moisten absorbent materials with water or primer.
- Seal the opening between the pipe and the CLT wall on both sides against smoke and fire with FIRESAFE FT Acrylic before installing a FIRESAFE FIRE COLLAR.
- Install a FIRESAFE FIRE COLLAR around the plastic pipe on both sides of the wall. Attach a FIRESAFE FIRE COLLAR to the CLT wall with four wood screws. Size M 5–6. Length 60–80 mm.

Note: Apply FIRESAFE FT Acrylic around the pipe as a smoke seal and Fire Stopping on both sides of the wall. Install a FIRE COLLAR around the pipe on both sides of the wall with four wood screws.

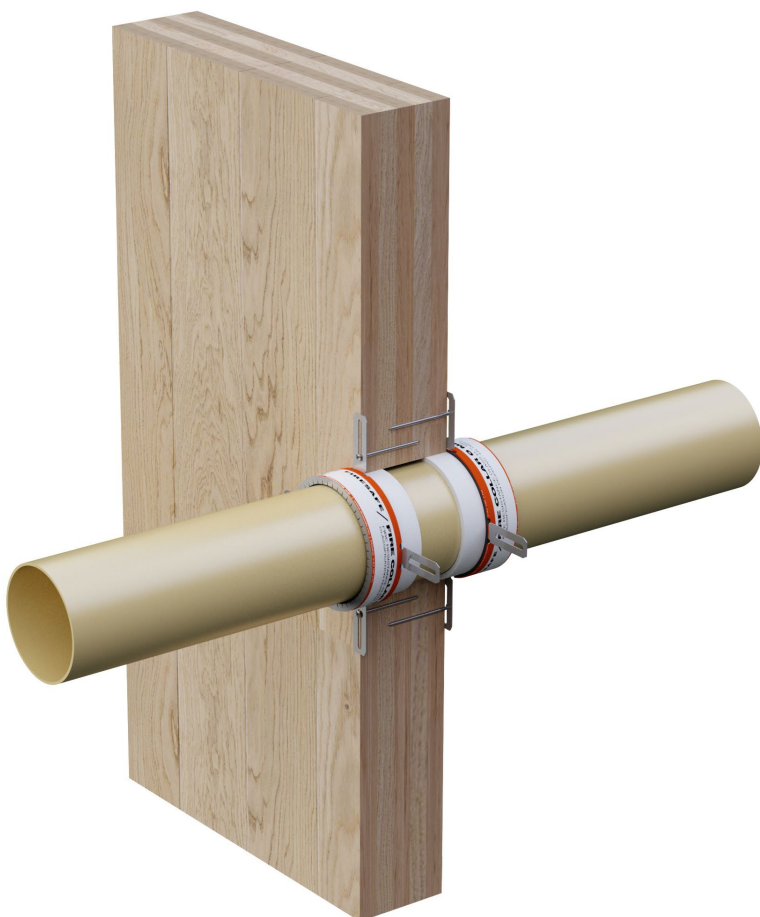
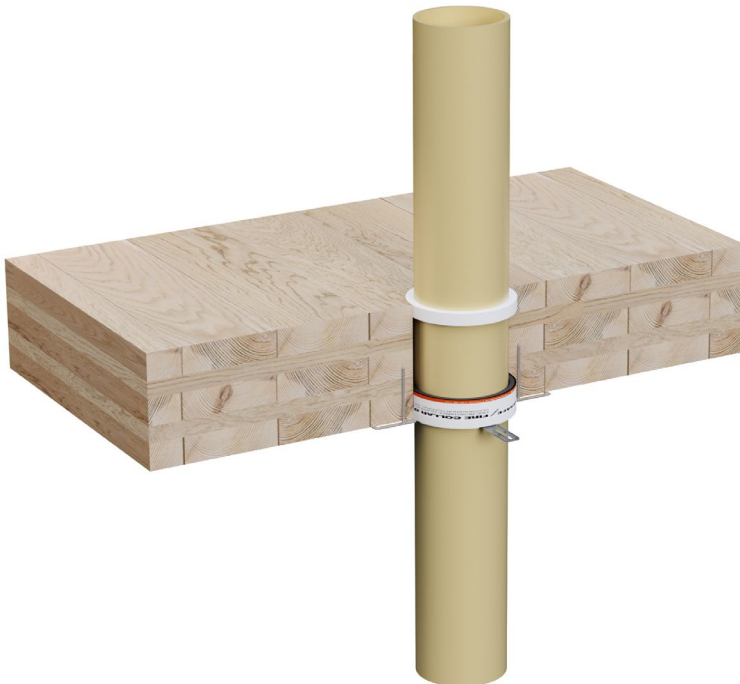

Table 78: CLT floor slab ≥ 140 mm.		
PP plastic pipe (d) $\leq \varnothing 110$ mm, (t) 6.3 mm. U/C.	Fire resistance class	See detail, figure:
PP plastic pipe (d) $\leq \varnothing 110$ mm, (t) 6.3 mm. U/C. Opening in floor slab d: $\varnothing 129$ mm. One-sided fire sealing using a FIRESAFE FIRE COLLAR installed on the exposed side.	E 90 – EI 90	Figure 78

Installation, Figure 78

- Remove any debris and dust from the opening.
- Moisten absorbent materials with water or primer.
- Install a FIRESAFE FIRE COLLAR, flush with the floor slab. A FIRESAFE FIRE COLLAR embedded in floor slabs is a specially tested solution for pipes where there is no space for an external installation, due to underlying pipe bends that would come close to the underside of the floor slab.
- Install a FIRESAFE FIRE COLLAR around the plastic pipe. Attach a FIRESAFE FIRE COLLAR to the CLT floor slab with four wood screws. Size M 5–6. Length 60–80 mm.
- Use FIRESAFE FT Acrylic to seal the opening between the CLT floor slab and a FIRESAFE FIRE COLLAR against smoke and fire.



Note: Install a FIRE COLLAR around the pipe on the underside of the floor slab with four wood screws. Apply FIRESAFE FT Acrylic around the pipe and a FIRE COLLAR as a smoke seal on both sides of the floor slab.



Table 79: CLT floor slab \geq 140 mm.		
PP-MD plastic pipe (d) \leq \varnothing 110 mm, with connecting sleeve, (t) 3.8 mm. U/C.	Fire resistance class	See detail, figure:
PP-MD plastic pipe (d) \leq \varnothing 110 mm, with connecting sleeve, (t) 3.8 mm. U/C. Opening in floor slab d: \varnothing 140 mm. One-sided Fire Stopping using a FIRESAFE FIRE COLLAR \varnothing 160 mm around the plastic pipe with connecting sleeve installed on the exposed side.	E 90 – EI 90	Figure 79

Installation, Figure 79

- Remove any debris and dust from the opening.
- Moisten absorbent materials with water or primer.
- Seal the opening between the CLT floor slab and the pipe against fire and smoke with FIRESAFE FT Acrylic on both sides of the floor slab. Sealant width \leq 15 mm x sealant depth \geq 10 mm.
- Install a FIRESAFE FIRE COLLAR \varnothing 160 mm connecting sleeve. Attach a FIRESAFE FIRE COLLAR to the CLT floor slab with four wood screws. Size M 5–6. Length 60–80 mm.
- Make sure that there is an equal distance all the way around the connecting sleeve and inside of the FIRE COLLAR. Max distance 20 mm. See Fig. 1.

- FIRESAFE FT Acrylic must not be applied between the plastic pipe itself and the inside of the FIRE COLLAR. (Fire and smoke sealing must only be in CLT floor slabs).



Note: Apply FIRESAFE FT Acrylic around the pipe and connecting sleeve on both sides of the floor slab. Sealant width \leq 30 mm x sealant depth \geq 10 mm. Install a FIRE COLLAR around the pipe on the underside of the floor slab with four wood screws.



Fig 1.

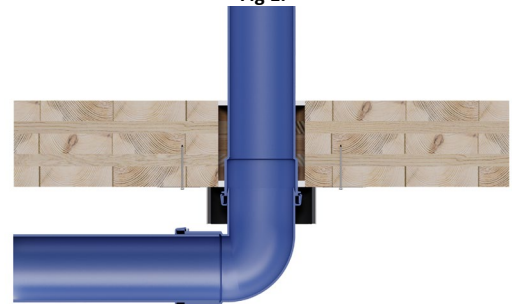

Table 80: CLT floor slab ≥ 140 mm.		
Aluminium pipe of type PE-X (d) $\leq \varnothing 16$ mm, (t) 2.25 mm. U/C.	Fire resistance class	See detail, figure:
Alu PE-X (d) $\leq \varnothing 16$ mm, (t) 2.25 mm. 13 mm Armaflex AF. U/C. Opening in floor slab d: $\varnothing 44$ mm.	E 90 – EI 90	Figure 80

Installation, Figure 80

- Remove any debris and dust from the opening.
- Moisten absorbent materials with water or primer.
- Create a smoke seal in the opening between the CLT and the insulated pipe with FIRESAFE FT Acrylic on both sides of the floor slab.
- Install a FIRESAFE FIRE COLLAR $\varnothing 50$ mm around the pipe insulation below the floor slab.
- Attach a FIRESAFE FIRE COLLAR to the CLT floor slab with four wood screws. Size M 5–6. Length 60–80 mm.



Note: Apply FIRESAFE FT Acrylic around the pipe insulation as a smoke seal on both sides of the floor slab. Install a FIRE COLLAR around the pipe insulation on the underside of the floor slab with four wood screws.



*Pipes insulated with 13 mm cellular rubber of type Armaflex AF. Fire rating, Euroclass B/BL, s3-d0.

LS: Continuous pipe insulation, 13 mm thick, with 350 mm extending out on each side of the floor slab.

CS: The specified insulation must run the entire length of the pipe or a minimum of 850 mm, including in the penetration itself.

INSTALLATION MANUAL

FIRE SEALING IN CLT CONSTRUCTIONS

Fire Stopping System Hand Book

FIRESAFE

Date: 19.11.2021

Prepared by: Pål Paulsen

Controlled by: Hallvard K Engøy

Rev.: 01

FIRESAFE WRAP LX

PRODUCT DESCRIPTION

FIRESAFE WRAP LX is a flexible strip for quick and easy installation in wall and floor structures.

FIRESAFE Fire Wrap is made of heat-expanding graphite material. The graphite material in FIRESAFE WRAP LX starts to expand at a temperature of 190 °C to at least 18 times its original volume after (30 minutes/550 °C).

AREAS OF USE

FIRESAFE WRAP LX is used as a Fire Stopping for large plastic pipes and aluminium pipes. It is also used as a fire sealing for steel and copper pipes insulated with combustible pipe insulation in walls and floors, to form a secure fire sealing throughout the entire structure.

FIRESAFE WRAP LX is available in 18 m rolls. Width 50 mm x 2.5 mm thickness.

Rolls of FIRESAFE WRAP LX can be easily cut with scissors or a knife to fit the pipe.

FIRESAFE WRAP LX can be installed in small, individual openings as penetration sealing in walls and floors or

multiple penetrations in large openings combined with FIRESAFE GPG MORTAR.

CERTIFICATION / FIRE RESISTANCE

- FIRESAFE FIRE WRAP has been tested in accordance with NS-EN 1366-3 (2009) and NS-EN 1366-4 (2009), as well as EN 13501-1/2.
- Certified in accordance with ETA 15/0026. FIRESAFE GPG MORTAR.
- Norwegian product documentation issued by RISE Fire Research AS: RISEFR AA-050 and RISEFR 030-0256.
- Fire resistance EI 60 to EI 240 with extensive areas of application for walls and floors.
- Fire-rated Plaster or masonry walls/precast structure (density 600–650 kg/m³) ≥ 100 mm.
- Fire-rated Masonry floor slabs/precast structure (density 600–650 kg/m³) ≥ 150 mm.
- Fire resistance class EI 90 in CLT structures (cross-laminated timber structures).

INSTALLATION

- Clean pipes to remove grease and moisture. Remove any debris and dust in the opening.
- For uneven surfaces in apertures and small holes, first use FIRESAFE FT Acrylic to improve the effectiveness of smoke sealing.
- Always install FIRESAFE WRAP LX on both sides of a wall and on one side (underside) of concrete floor slabs.
- FIRESAFE WRAP LX must be fitted tightly around the pipe.
- Fasten FIRESAFE WRAP LX around the pipe with plastic tape to keep it in place.
- Seal openings smaller than 15 mm between the structure and FIRESAFE WRAP LX with FIRESAFE FT Acrylic.
- Seal openings larger than 15 mm between the structure and FIRESAFE WRAP LX with FIRESAFE GPG MORTAR.

ARTICLE / ARTICLE NAME / SIZE

- 104020: FIRESAFE WRAP LX on an 18 m roll, packed in a cardboard box.

STORAGE/ SHELF LIFE

- Store in a dry place, between +5 °C and +30 °C. Best stored in a cool and dark place.
- Shelf life of multiple years in unopened packaging.
- Should be protected from frost.

SAFETY

- FIRESAFE WRAP LX is solvent free and environmentally friendly. Not known to be an irritant in the event of contact with skin, but avoid contact with eyes or mouth. See separate material safety data sheet for FIRESAFE WRAP LX.



Table 81: CLT floor slab \geq 140 mm.		
PP plastic pipe (d) \leq \varnothing 110 mm, (t) 6.3 mm. U/C.	Fire resistance class	See detail, figure:
PP plastic pipe (d) \leq \varnothing 110 mm, (t) 6.3 mm. U/C. Opening in floor slab d: \varnothing 122 mm. One-sided fire sealing using FIRESAFE WRAP LX installed on the exposed side.	E 90 – EI 90	Figure 81

Installation, Figure 81

- Remove any debris and dust from the opening.
- Moisten absorbent materials with water or primer.
- Apply 2 x 2 layers of 2.5 mm thick FIRESAFE WRAP LX around the pipe, flush with the underside of the floor slab.
- Fasten FIRESAFE WRAP LX around the pipe with plastic tape to keep it in place.
- Use FIRESAFE FT Acrylic to seal the opening between the CLT floor slab and FIRESAFE WRAP LX against smoke and fire.



Note: Apply 2 x 2 layers of FIRESAFE WRAP LX around the plastic pipe, on underside of the floor slab. Apply FIRESAFE FT Acrylic around the pipe as a smoke seal and fire sealing on both sides of the floor slab.



FIRESAFE EX heat-expanding sealant

PRODUCT DESCRIPTION

FIRESAFE EX is an acrylic-based sealant that contains heat-expanding graphite material. The sealant reacts to heat and starts expanding at a temperature of 150 °C. Expands in volume by 13 times the applied sealant thickness at 550 °C. The sealant expands at high pressure: 0.9 N/mm². The sealant has excellent properties in that it seals combustible installation penetrations and openings or cavities within a matter of minutes.

AREAS OF USE

- Penetration sealing of metal pipes with combustible and non-combustible pipe insulation.
- Penetration sealing of plastic pipes of type PE-Xa with combustible and non-combustible pipe insulation.
- Penetration sealing of single and bundled plastic electrical conduits.
- Penetration sealing of individual and large bundled electrical CU cables or telecommunications cables.
- Penetration sealing of combustible pipes for heating, ventilation and sanitation (PE-PP- PVC (d) ≤ Ø110 mm).
- Vertical and horizontal joints with combustible and non-combustible infill.

FIRESAFE EX sealant is used in combination with FIRESAFE GPG MORTAR. See also the installation instructions for FIRESAFE GPG MORTAR for details.

CERTIFICATION / FIRE RESISTANCE / ARTICLE NO. / EL NO.

- FIRESAFE EX sealant has been tested in accordance with NS-EN 1366-3 (2009) and EN 13501-1/2.
- Certified in accordance with ETA 16/0813 Firesafe EX / ETA 16/0309 PROMASEAL AG.
- Certified in accordance with ETA 15/0026. FIRESAFE GPG MORTAR.
- Fire resistance EI 30 to EI 120 with extensive areas of application for walls and floors.

FIRESAFE EX sealant is used in combination with FIRESAFE GPG MORTAR. See also the installation instructions for FIRESAFE GPG MORTAR for details.

- CLT walls (density 420 kg/m³) thickness ≥ 100 mm.
- CLT floor slabs (density 420 kg/m³) thickness ≥ 140 mm.
- CLT floor slabs (density 420 kg/m³) thickness ≥ 140 mm with thermal EPS insulation – sound attenuation panel of mineral wool – concrete screed thickness ≥ 270 mm.
- Plaster or masonry walls/precast structure (density 600–650 kg/m³) ≥ 100 mm.
- Floor slabs of masonry/precast structure (density 600–650 kg/m³) ≥ 150 mm.
- Approved as a smoke seal in accordance with EN 1634-3.
- For more information, see www.firesafe.no.
- FIRESAFE Article no.: 100 006 / FIRESAFE EI no: 127840.

APPLICATION

- Ensure that any openings to be sealed with Firesafe EX are free from dust and grease.
- Treat absorbent materials with water or primer first.
- Push mineral wool infill into the opening. See also FIRESAFE GPG MORTAR installation instructions for details.
- Smooth the sealant over the opening. If neat edges are desired, use masking tape.
- The sealant can normally be painted after 24 hours.
- Firesafe EX must not be applied at temperatures lower than +5 °C.
- Apply the sealant using a sealant gun and a standard sealant finishing tool.

PACKAGING/APPEARANCE

- Plastic cartridge for standard sealant gun: contents 310 ml.
- Supplied in boxes of 12 cartridges.
- Colour grey.

STORAGE/ SHELF LIFE

- Store in a dry place, between +3 °C and +35 °C. Best stored in a cool and dark place. Shelf life: at least 12 months in unopened packaging.
- Must be protected from frost.

SAFETY FACTORS

- The sealant is solvent free and environmentally friendly. It is recommended to use gloves when applying the sealant. Avoid contact with eyes or mouth. See separate material safety data sheet for FIRESAFE EX heat-expanding sealant.



Table 82: CLT floor slab ≥ 140 mm.		
PP plastic pipe (d) $\leq \varnothing 110$ mm, (t) 6.3 mm. U/C.	Fire resistance class	See detail, figure:
PP plastic pipe (d) $\leq \varnothing 110$ mm, (t) 6.3 mm. U/C. Opening in floor slab d: $\varnothing 140$ mm. Double-sided fire sealing with FIRESAFE EX installed on both sides of the floor slab.	E 90 – EI 90	Figure 82

Installation, Figure 82

- Remove any debris and dust from the opening.
- Moisten absorbent materials with water or primer.
- Openings around the plastic pipe in CLT are sealed with FIRESAFE EX, an expanding sealant, to a width of 15 mm and a depth of 25 mm.

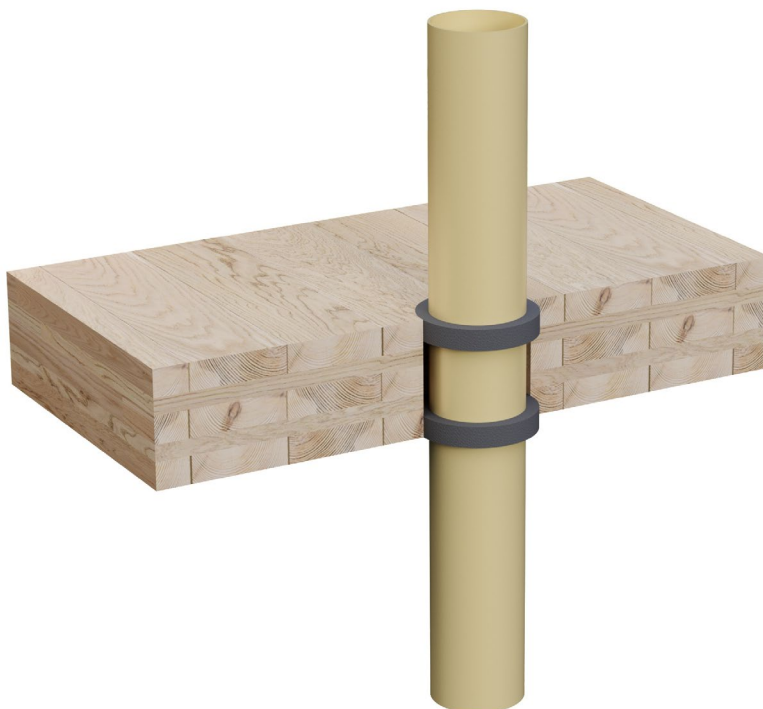

Note: Apply FIRESAFE EX around the plastic pipe, flush with the floor slab on both sides. Width 15 mm x 25 mm depth.

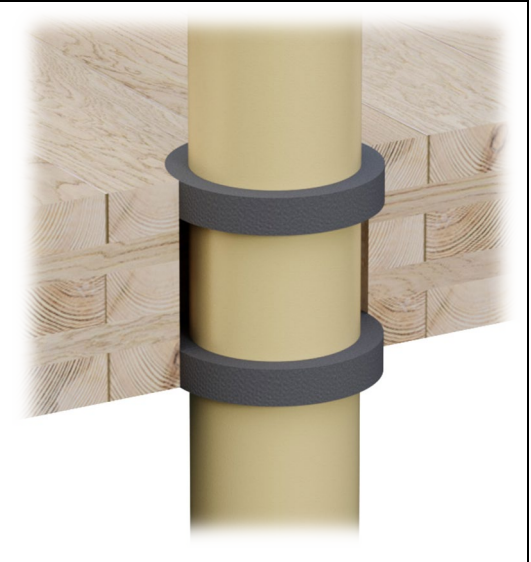

Schematic diagram.



Table 83: FIRESAFE FT GRAPHITE. SOLUTION IN CASE OF DEVIATIONS IN THE SIZE OF THE OPENING IN CLT.

EXAMPLE: PP-PE plastic pipes (d) ≤ Ø 110 mm.	See detail, figure:
Oversized openings in CLT can be ≤ 31 mm on one side of the pipe. Double-sided fire sealing with FIRESAFE FT Graphite.	Figure 83

Installation, Figure 83

- Seal the opening between the pipe and the CLT with FIRESAFE FT Graphite at a width of 15 mm and a depth of 25 mm.
- The opening between the pipe and the CLT can be ≤ 31 mm on one side of the pipe. The other side of the pipe must have a sealant width of 15 mm.
- Apply FIRESAFE FT Graphite on both sides, flush with the CLT floor slab on both sides.



Note: Apply FIRESAFE FT Graphite around the plastic pipe with a sealant width ≤ 31 mm on one side of the pipe. Seal the remaining opening around the pipe to a width of 15 mm. Apply FIRESAFE FT Graphite to a depth of 25 mm, flush with the floor slab on both sides.



Table 84: FIRESAFE GPG MORTAR. SOLUTION IN CASE OF DEVIATIONS IN THE SIZE OF THE OPENING IN CLT.

EXAMPLE: Cast iron pipe (d) ≤ Ø 110 mm.	See detail, figure:
An oversized opening in CLT can be 41 mm or larger on one or both sides of the pipe. Fire sealing throughout the opening with FIRESAFE GPG MORTAR.	Figure 84

Installation, Figure 84

The opening around the pipe is sealed with FIRESAFE GPG MORTAR to a thickness of 250 mm.

- The opening between the pipe and the CLT can be ≤ 41 mm or larger on one side of the pipe. The other side of the pipe must have a fire sealing width of 25 mm.
- For floor slabs less than 250 mm thick, use GPG MORTAR to make a casing around the pipe on the upper side of the CLT floor slab so that the total fire sealing thickness with GPG MORTAR is 250 mm.
- The GPG MORTAR casing around the pipe must be at least 25 mm thick.
- The solution can be implemented in the same way for floor slabs with thermal insulation and screed, or as a continuous fire sealing in floor slabs ≥ 240 mm.

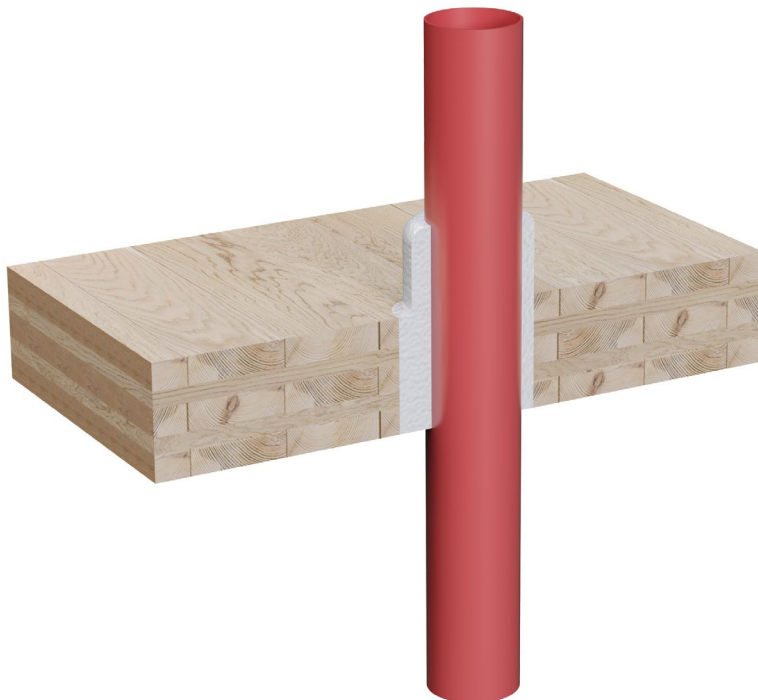

Note: Apply FIRESAFE GPG MORTAR around the pipe. Minimum fire sealing width 25 mm x minimum Fire Stopping depth 250 mm, flush with the underside of the floor slab.

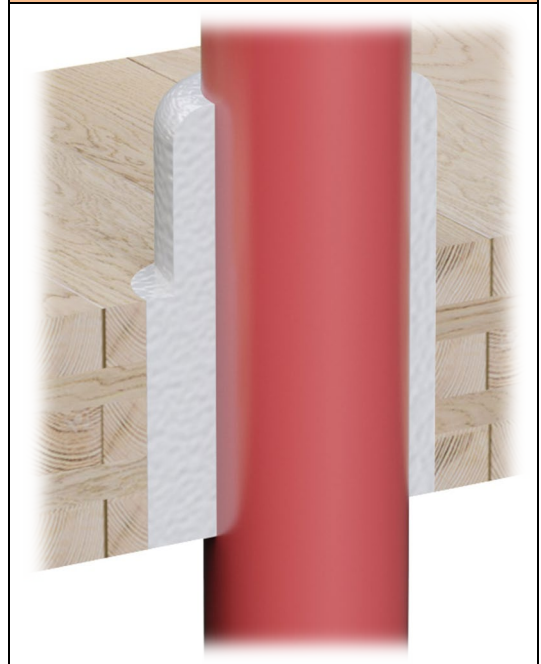
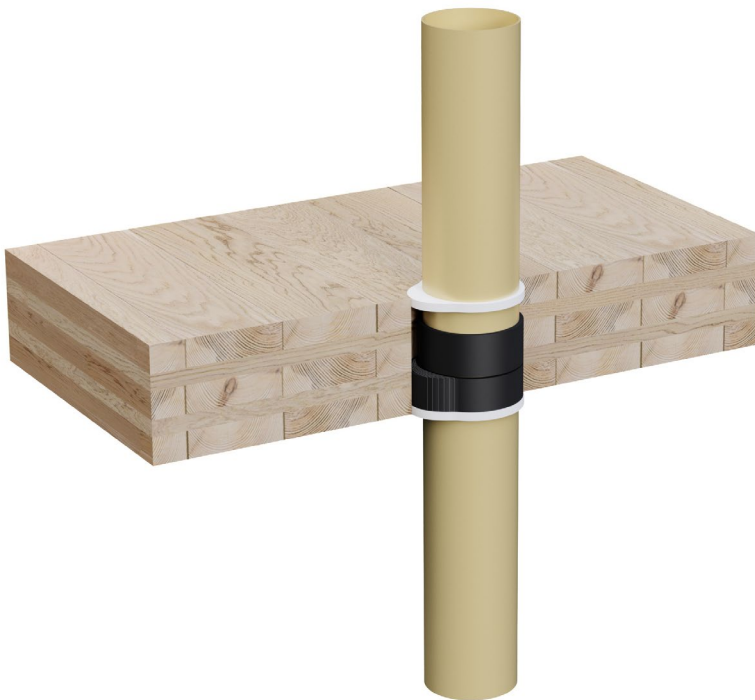

Table 85: FIRESAFE FIRE WRAP. SOLUTION IN CASE OF DEVIATIONS IN THE SIZE OF THE OPENING IN CLT.	
EXAMPLE: PP-PE plastic pipes (d) ≤ Ø 110 mm.	See detail, figure:
Oversized openings in CLT ≤ 20 mm on one side of the pipe. One-sided fire sealing using FIRESAFE FIRE WRAP installed on the exposed side.	Figure 85

Installation, Figure 85

- Apply 2 x 2 layers of 2 mm thick FIRESAFE FIRE WRAP around the pipe, flush with the underside of the floor slab.
- Cut pieces of FIRESAFE FIRE WRAP for precise sealing of the remaining opening between the FIRE WRAP and the edge of the fire sealing on the underside of the CLT floor slab.
- Pieces of FIRESAFE FIRE WRAP can be bonded together with FIRESAFE FT GRAPHITE sealant. Then, press appropriately sized pieces into the opening.
- Seal the opening between the pipe and the CLT against smoke and fire with FIRESAFE FT Acrylic on both sides of the CLT floor slab.
- The solution can be implemented in the same way for floor slabs with thermal insulation and screed.



Note: Apply 2 x 2 layers of FIRE WRAP around the plastic pipe, flush with the underside of the floor slab. Use appropriately sized pieces/lengths to precisely seal the remaining opening between the FIRE WRAP and the edge of the fire sealing.
Seal the opening between the pipe and the CLT against smoke and fire with FIRESAFE FT Acrylic on both sides of the CLT floor slab.



Table 86: FIRESAFE WRAP LX. SOLUTION IN CASE OF DEVIATIONS IN THE SIZE OF THE OPENING IN CLT.	
EXAMPLE: PP-PE plastic pipes (d) ≤ Ø 110 mm.	See detail, figure:
Oversized openings in CLT ≤ 21 mm on one side of the pipe. One-sided fire sealing using FIRESAFE WRAP LX installed on the exposed side.	Figure 86

Installation, Figure 86

- Apply 2 x 2 layers of 2.5 mm thick FIRESAFE WRAP LX around the pipe, flush with the underside of the floor slab.
- Cut pieces of FIRESAFE WRAP LX for precise sealing of the remaining opening between the WRAP LX and the edge of the fire sealing on the underside of the CLT floor slab.
- Pieces of FIRESAFE WRAP LX can be bonded together with FIRESAFE EX sealant. Then, press appropriately sized pieces into the opening.
- Seal the opening between the pipe and the CLT against smoke and fire with FIRESAFE FT Acrylic on both sides of the CLT floor slab.
- The solution can be implemented in the same way for floor slabs with thermal insulation and screed.

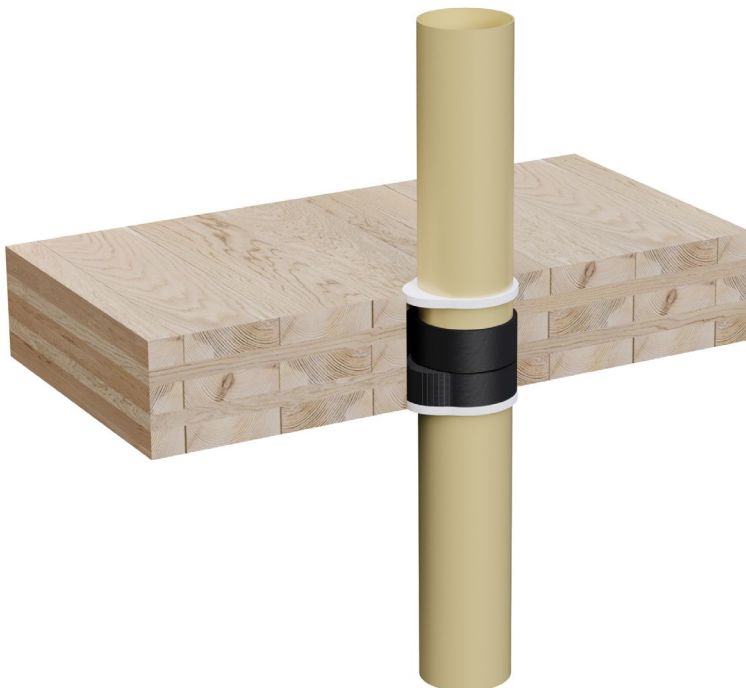

Note: Apply 2 x 2 layers of WRAP LX around the plastic pipe, flush with the underside of the floor slab. Use appropriately sized pieces/lengths to precisely seal the remaining opening between the WRAP LX and the edge of the fire sealing.
Seal the opening between the pipe and the CLT against smoke and fire with FIRESAFE FT Acrylic on both sides of the CLT floor slab.



Table 87: FIRESAFE EX SEALANT. SOLUTION IN CASE OF DEVIATIONS IN THE SIZE OF THE OPENING IN CLT.	
EXAMPLE: PP-PE plastic pipes (d) ≤ Ø 110 mm.	See detail, figure:
Oversized openings in CLT can be ≤ 31 mm on one side of the pipe. Double-sided fire sealing with FIRESAFE EX expanding sealant.	Figure 87

Installation, Figure 87

- Seal the opening between the pipe and the CLT with FIRESAFE EX at a width of 15 mm and a depth of 25 mm.
- The opening between the pipe and the CLT can be ≤ 31 mm on one side of the pipe. The other side of the pipe must have a sealant width of 15 mm.
- Apply FIRESAFE EX on both sides, flush with the CLT floor slab on both sides.



Note: Apply FIRESAFE EX around the plastic pipe with a sealant width ≤ 31 mm on one side of the pipe. Seal the remaining opening around the pipe to a width of 15 mm. Apply FIRESAFE EX to a depth of 25 mm, flush with the floor slab on both sides.

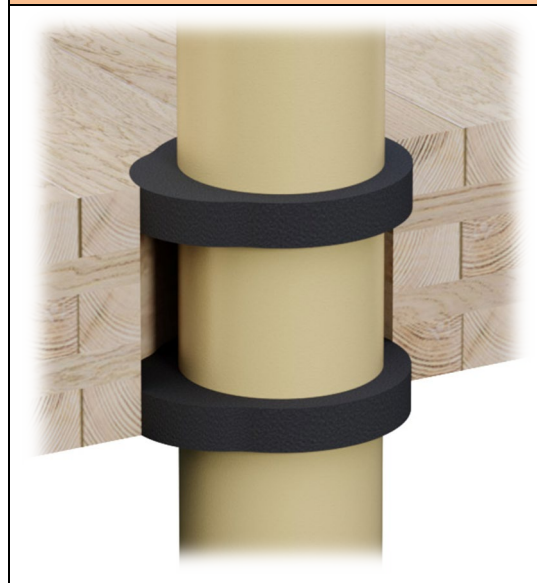

Explanations of abbreviations for pipe insulation (see NS-EN 1366-3: 2009, Table 1):

LS: Pipe insulation in the specified length locally on both sides, also in the penetration itself.

CS: Continuous pipe insulation, on both sides, also in the penetration itself.

LI: Pipe insulation in the specified length locally on both sides, excluding the penetration itself.

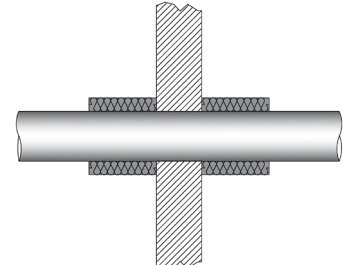
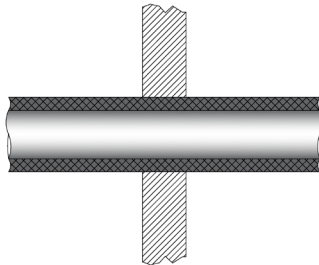
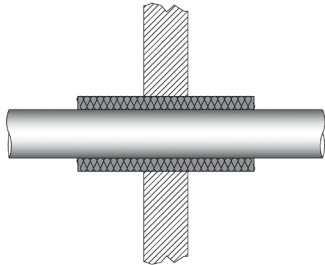

Tested solutions for insulating pipes were implemented in such a way that all possible variations were covered (ref. NS-EN 1366-3: 2009):

LI: Interrupted pipe insulation in the penetration with cellular rubber pipe replaced with mineral wool or ceramic fibre pipe insulation.

LS: Specified insulation with specified length on both sides from the wall or floor slab, and in the penetration itself.

LS: Tested solutions for LS can also be used as **CS**.

CS: Specified insulation is continuous along the entire length of the pipe, including the penetration.

CS – LS – LI: Thickness and density of the pipe insulation in the tables can be increased but not reduced.

LS – LI: Pipe insulation lengths can be increased but not reduced.

Explanations of abbreviations for pipe end configuration in test (see NS-EN 1366-3: 2009, Table 2):

U/U: Uncapped on exposed side / Uncapped on unexposed side.

Uncapped/uncapped, ventilated pipe systems e.g. wastewater and rain water pipes

C/U: Capped on exposed side / Uncapped on unexposed side.

Capped/uncapped, non-ventilated pipe systems, e.g. hot and cold water pipes.

U/C: Uncapped on exposed side / Capped on unexposed side.

Uncapped/capped, non-ventilated pipe systems, e.g. hot and cold water pipes.

C/C: Capped on exposed side / Capped on unexposed side.

Capped/capped. Closed pipe systems with permanent water pressure such as water supply and sprinkler pipes.

(t): Pipe wall thickness (t) is the thickness of pipes.

Table E.1. Pipe end (ref. NS-EN 1366-3: 2009)

Application covered	Tested pipe end configuration			
	U/U	C/U	U/C	C/C
U/U	Yes	No	No	No
C/U	Yes	Yes	No	No
U/C	Yes	Yes	Yes	No
C/C	Yes	Yes	Yes	Yes

Distances: General rules

For single or multiple pipe penetrations, pipe insulation is applied as an **LS** or **CS** configuration. The distance between the pipe and the edge of the fire sealing must be calculated from the outside of the pipe insulation against the edge of the fire sealing. See [a1](#): Fig 1.

For single or multiple pipe penetrations, pipe insulation is applied as an **LI** configuration. The distance between the pipe and the edge of the fire sealing must be calculated from the outside of the pipe against the edge of the fire sealing. See [a1](#): Fig 1.

The distance between multiple holes must be ≥ 200 mm. See distance [a2](#): Fig 1.

Fig 1.

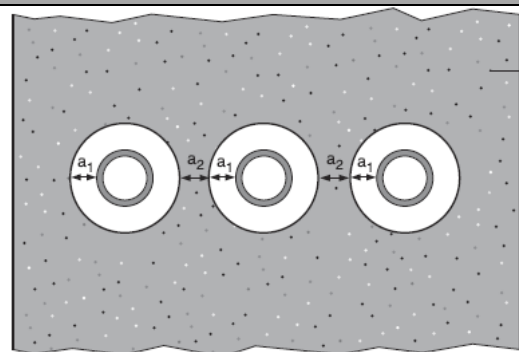

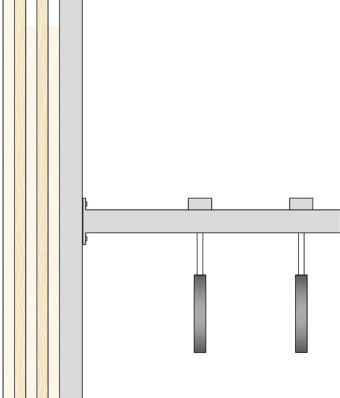
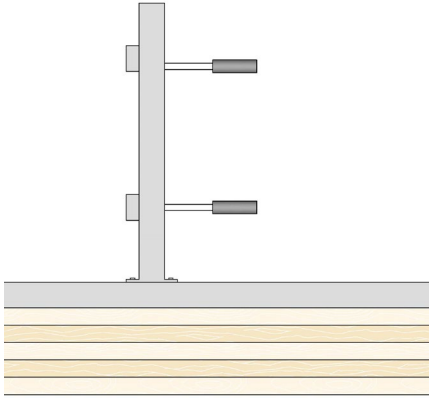
Service support / suspension systems for cables and pipes (ref. NS-EN 1366-3: 2009, Table 3):	
Distances for service support on both sides of the wall. Nearest support 229–250 mm. Outermost support 409–430 mm.	Distances for service support on the unexposed side of the floor slab with and without screed. Nearest support 100–140 mm. Outermost support 340 mm.
	

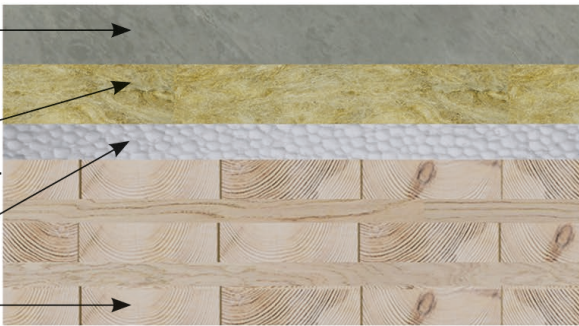
Schematic diagram for the construction of a CLT floor slab with thermal insulation and screed.	
50 mm thick cement screed, cement-based levelling compound or concrete	
Sound attenuation panel of 50 mm thick mineral wool, density ≥ 90 kg/m ³	
Thermal insulation of 30 mm thick combustible EPS, also called polystyrene	
CLT 140 thickness ≥ 140 mm	

Schematic diagram for correct measurement of sealant depth.



Note:

- When applying sealant, use a metre stick. The sealant should generally be applied to a depth of 25 mm.
- For high sound attenuation requirements, use mineral wool infill with a density of $\geq 50 \text{ kg/m}^3$. This will also help to keep the sealant in place.
- Minor deviations in sealant widths are permitted, for example, a specified width of 10 mm may in reality be only 7 mm wide.
- In such cases, apply a greater depth of sealant so that the degree of filling with heat-expanding sealant is the same as specified.

Principles for installing insulation for pipes and ventilation ducts, as well as requirements for corrosion protection of metal pipes.

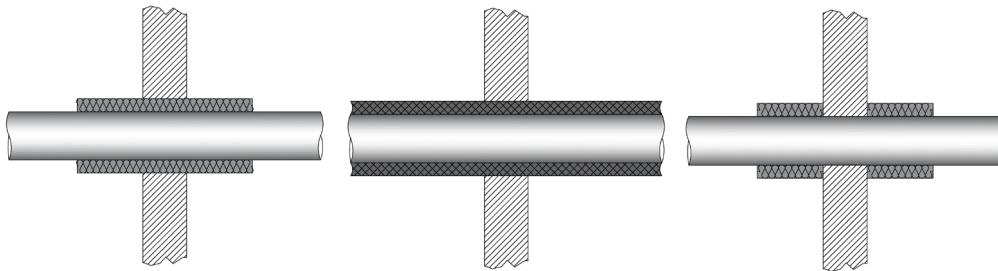

Note:

- Installation of mineral wool pipe and duct insulation must be in accordance with instructions from the manufacturer/product supplier.
- Use steel wire approx. CC 200 to hold the insulation in place on each side of the fire barrier structure.
- Use Alu Coat tape for all joints to ensure that they are sealed.
- Installation of cellular rubber pipe insulation must be in accordance with instructions from the manufacturer/product supplier.
- Cellular rubber condensation insulation can be made from panels or pipe or tubular sections adapted to the pipe diameter.
- All joints must be bonded in accordance with the manufacturer/product supplier's instructions and 3 mm thick tape of the same material.
- All metal pipes not completely covered in pipe insulation must be corrosion protected before fire sealing is installed. This can be achieved by using steel primer or steel paint. This is the plumber's responsibility.

INSTALLATION MANUAL

FIRE STOPPING IN CLT STRUCTURES

Fire Stopping System Hand Book

FIRESAFE /

Date: 19.11.2021

Prepared by: Pål Paulsen

Reviewed by: Hallvard K Engøy

Rev.: 01

DOCUMENTATION INFORMATION

These installation instructions contain an overview of areas of use and fire resistance ratings.

Other documentation such as product data sheets, safety data sheets (SDS) and declarations of performance (DoP) can be downloaded from www.firesafe.no.

Product certification with/by declaration of performance; for more information, see certification of CE-marked construction products through ETA on www.eta.eu/.

Product documentation for Norway issued by RISE Fire Research AS can be downloaded from www.risefr.no.

Always consult www.firesafe.no for the latest versions of installation instructions, product data sheets and the declaration of performance (DoP), as product development and testing are continuous processes at FIRESAFE AS.

Contact the technical department at FIRESAFE for other EI requirements, non-standardised solutions or complex, project-specific requirements; email: firmapost@firesafe.no.

Author:

Pål Paulsen

*Technical Department – Product Manager Fire Sealing Products
Fire testing and product development*

Signature:

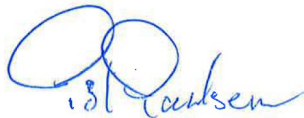

Controlled By:

Hallvard. K Engøy

Technical Manager

Signature:

