



designated according to Article 29 of the Regulation (EU) No 305/2011 and member of EOTA (European Organisation for Technical Assessment, www.eota.eu)

European Technical Assessment

**ETA 25/0235
of 30/04/2025**

Technical Assessment Body issuing the ETA and designated according to Article 29 of the Regulation (EU) No 305/2011: UL International (Netherlands) B.V.

Trade name of the construction product

FIRESAFE / FSA

Product family to which the construction product belongs

Fire Stopping and Sealing Product:
• Linear Joint and Gap Seals

Manufacturer

Firesafe AS
Robsrudskogen 15
1470 Lørenskog
Norway

Manufacturing plant(s)

L/002

This European Technical Assessment contains

39 pages including 1 Annex which form an integral part of this assessment.

This European Technical Assessment is issued in accordance with regulation (EU) No 305/2011, on the basis of

EAD 350141-00-1106, September 2017.

Translations of this European Technical Assessment in other languages shall fully correspond to the original issued document and should be identified as such.

Communication of this European Technical Assessment, including transmission by electronic means, shall be in full. However, partial reproduction may be made, with the written consent of the issuing Technical Assessment Body. Any partial reproduction has to be identified as such.

I. SPECIFIC PARTS OF THE EUROPEAN TECHNICAL ASSESMENT	3
1. Technical description of the product	3
2. Specification of the intended uses of the product in accordance with the applicable European Assessment Document (hereinafter EAD): EAD 350141-00-1106	3
3. Performance of the product and references to the methods used for its assessment	4
4. Assessment and Verification of Constancy of Performance (hereinafter AVCP) applied, with reference to its legal base	5
5. Technical details necessary for the implementation of the AVCP system, as provided for in the applicable EAD	5

Annex - Resistance to Fire Classification - FIRESAFE / FSA

Annex A	7
----------------	----------

I. SPECIFIC PARTS OF THE EUROPEAN TECHNICAL ASSESSMENT

1. Technical description of the product

- 1) FIRESAFE / FSA is a sealant used to form linear gap seals where gaps are present in wall and floor constructions and linear joint seals where wall and floor constructions abut.
- 2) FIRESAFE / FSA is supplied in liquid form contained within 310 ml cartridges, 600 ml foil packs, 6kg and 12.5kg buckets. The sealant is gunned or trowelled into the aperture in the separating element/elements.
- 3) The use category of FIRESAFE / FSA in relation to BWR 3 (Hygiene, health and environment) is IA1, S/W2.
The applicant has submitted a written declaration that FIRESAFE / FSA does not contain substances which have to be classified as dangerous according to Directive 67/548/EEC and Regulation (EC) No 1272/2008 and listed in the "Indicative list on dangerous substances" of the EGDS - taking into account the installation conditions of the construction product and the release scenarios resulting from there.
In addition to the specific clauses relating to dangerous substances contained in this European technical Assessment, there may be other requirements applicable to the products falling within its scope (e.g. transposed European legislation and national laws, regulations and administrative provisions). In order to meet the provisions of the Construction Products Regulation, these requirements need also to be complied with, when and where they apply.

2. Specification of the intended uses of the product in accordance with the applicable European Assessment Document (hereinafter EAD): EAD 350141-00-1106

Detailed information and data is given in Annex A.

- 1) The intended use of system FIRESAFE / FSA is to reinstate the fire resistance performance of gaps in and joints in and between flexible wall and rigid wall constructions, gaps in and joints between rigid floor constructions.
- 2) The specific elements of construction that the system FIRESAFE / FSA may be used to provide a linear joint or gap seal with specific supporting constructions and substrates, are as follows:
 - a) Flexible walls: The wall must have a minimum thickness of 100 mm. Apertures in flexible walls are not required to be lined.
 - b) Rigid walls: The wall must have a minimum thickness of 100 mm and comprise concrete, aerated concrete or masonry, with a minimum density of 350 kg/m³.
 - c) Rigid floors: The floor must have a minimum thickness of 150 mm and comprise aerated concrete or concrete with a minimum density of 400 kg/m³.
 - d) Metal deck floors: The floor must have a minimum (over-all) thickness of 150 mm and comprise of aerated concrete or concrete with a minimum density of 400 kg/m³. The metal should have a minimum thickness of 0.7 mm.
The supporting construction must be classified in accordance with EN 13501-2 for the required fire resistance period.

- 3) The maximum permitted joint/gap width for the FIRESAFE / FSA system is 100mm.

Test conditions	Designation
Specimen orientation - Horizontal supporting construction - Vertical supporting construction - vertical joint - Vertical supporting construction - horizontal joint	H V T
Movement capability - No movement	X
Type of splices - Manufactured - Field - Both manufactured and field	M F B
Joint width range (in mm)	W00 - 99

The maximum movement capability of FIRESAFE / FSA is $\leq 7.5\%$.

- 5) The provisions made in this European Technical Assessment are based on an assumed working life of the FIRESAFE / FSA of 25 years, provided that the conditions laid down in the product data sheet regarding packaging/transport/storage/installation/use/repair are met. The indications given on the working life cannot be interpreted as a guarantee given by the producer or the Technical Assessment Body but are to be regarded only as a means for choosing the right products in relation to the expected economically reasonable working life of the works.
- 6) Type Z₂: Intended for uses in internal conditions with humidity level lower than 85% RH, excluding temperatures below 0°C, without exposure to rain or UV.
- 7) It is allowed to replace PE / PU Foam backing with mineral wool backing.
Stone wool backing may be replaced by any mineral wool backing with the same or higher density.
Stone wool backing may also be replaced by Mulcol® Multitherm backing.
- 8) Depth of mineral wool backing may be increased.

3. Performance of the product and references to the methods used for its assessment

Product-type: Sealant		Intended use: Linear Joint and Gap Seal
Assesment method	Essential characteristic	Product Performance
<u>BWR 2 Safety in case of fire</u>		
EN 13501-1	Reaction to fire	E
EN 13501-2	Resistance to fire	Annex A
<u>BWR 3 Hygiene, health and enviroment</u>		
EN 1026	Air permeability	No performance determined
EAD 350454-00-1106, Annex C	Water permeability	No performance determined
Declaration of manufacturer & EN 16516	Release of dangerous substances	IA1, S/W 2 - Declaration of manufacturer
<u>BWR 4 Safety in use</u>		
EOTA TR 001:2003	Mechanical resistance and stability	No performance determined
EOTA TR 001:2003	Resistance to impact/movement	No performance determined
EOTA TR 001:2003	Adhesion	No performance determined
EAD 350141-00-1106, Clause 2.2.12	Durability	Z ₂
ISO 11600	Movement capability	≤ 7.5%
EAD 350141-00-1106, Clause 2.2.14	Cycling of perimeter for curtain walls	No performance determined
EAD 350141-00-1106, Clause 2.2.15	Compression set	No performance determined
EAD 350141-00-1106, Clause 2.2.16	Linear expansion on setting	No performance determined
<u>BWR 5 Protection against noise</u>		
EN 10140-1,2,4,5 / EN ISO 7171-1	Airborne sound insulation	R _w (C;C _{tr}) = 54 (-3;-10) dB
<u>BWR 6 Energy economy and theat retention</u>		
EN 12664, EN 12667, EN 12939, EN ISO 8990, EN ISO 6946, EN ISO 14683, EN ISO 10211, EN ISO 10456	Thermal properties	No performance determined
EN ISO 12572, EN 12086, EN ISO 10456	Water vapour permeability	No performance determined

4. Assessment and Verification of Constancy of Performance (hereinafter AVCP) applied, with reference to its legal base

According to the decision 1999/454/EC – Commission Decision of date 22nd June 1999 on the procedure for attesting the conformity of construction products pursuant to Article 20(2) of Council Directive 89/106/EEC as regards to fire stopping, fire sealing and fire protective products, published in the Official Journal of the European Union (OJEU) L178/52 of 14/07/1999, see <http://eur-lex.europa.eu/JOIndex.do> of the European Commission¹, as amended, the system(s) of assessment and verification of constancy of performance (see Annex V to Regulation (EU) No 305/2011) given in the following table(s) applies (apply).

Product(s)	Intended use(s)	Level(s) or class(es)	System(s)
Fire stopping and Fire Sealing Products	For fire compartmentation and/or fire protection or fire performance	Any	1

5. Technical details necessary for the implementation of the AVCP system, as provided for in the applicable EAD

Tasks of the manufacturer:

Factory production control

The manufacturer shall exercise permanent internal control of production. All the elements, requirements and provisions adopted by the manufacturer shall be documented in a systematic manner in the form of written policies and procedures, including records of results performed. This production control system shall ensure that the product is in conformity with this European Technical Assessment.

The factory production control shall be in accordance with the Control Plan of 14 September 2023 relating to the European Technical Assessment ETA 25/0235 issued on 30/04/2025 which is part of the technical documentation of this European Technical Assessment. The “Control Plan” is laid down in the context of the factory production control system operated by the manufacturer and deposited at UL International (Netherlands) B.V.

The results of factory production control shall be recorded and evaluated in accordance with the provisions of the Control Plan.

Other tasks of the manufacturer:

Additional information

The manufacturer shall provide a technical data sheet and an installation instruction with the following minimum information:

(a) Technical data sheet:

- Field of application:
- Building elements for which the penetration seal is suitable, type and properties of the building elements like minimum thickness, density, and - in case of lightweight constructions - the construction requirements.
- Limits in size, minimum thickness etc. of the penetration seal
- Construction of the penetration seal including the necessary components and additional products (e.g. backfilling material) with clear indication whether they are generic or specific.
- Services which the penetration seal is suitable, type and properties of the services like material, diameter, thickness etc. in case of pipes including insulation materials; necessary/allowed supports/fixings (e.g. pipe trays)

(b) Installation instruction:

- Steps to be followed
- Procedure in case of retrofitting
- Stipulations on maintenance, repair and replacement

6. Issued on:

30 April 2025

Report by:

Verified by:

Validated by:



P. Foster

C. Johnson

R. Qaradeh

Project Engineer Associate

Senior Staff Engineer

Head of TAB

Built Environment

Built Environment

For and on behalf of UL International (Netherlands) B.V.

Annex A - Resistance to Fire Classification - FIRESAFE / FSA

A.1.1	Flexible wall - Wooden frame	6
A.1.1.1	Flexible wall ≥ 100 mm - Wooden frame - w15 x d10 mm, either side	6
A.1.1.2	Flexible wall ≥ 100 mm - Wooden frame - w30 x d10 mm, both sides	7
A.1.2	Flexible wall to rigid wall - Vertical	8
A.1.2.1	Flexible wall ≥ 100 mm - Rigid wall ≥ 100 mm - w15 x d12.5 mm, both sides	8
A.1.2.2	Flexible wall ≥ 100 mm - Rigid wall ≥ 100 mm - w15 x d25 mm, both sides	9
A.1.2.3	Flexible wall ≥ 100 mm - Rigid wall ≥ 100 mm - w30 x d12.5 mm, both sides	10
A.1.3	Flexible wall to rigid floor - Horizontal	11
A.1.3.1	Flexible wall ≥ 100 mm - Rigid floor ≥ 150 mm - w30 x 12.5 mm, both sides	11
A.1.3.2	Flexible wall ≥ 100 mm - Rigid floor ≥ 150 mm - w30 x 25 mm, both sides	12
A.1.3.3	Flexible wall ≥ 100 mm - Rigid floor ≥ 150 mm - w30 x d12.5 mm, both sides	13
A.1.4	Rigid wall to rigid wall - Vertical	14
A.1.4.1	Rigid wall ≥ 100 mm - w15 x d10 mm, both sides	14
A.1.4.2	Rigid wall ≥ 100 mm - w15 x d10 mm, either side	15
A.1.4.3	Rigid wall ≥ 100 mm - w30 x d15 mm, both sides	16
A.1.4.4	Rigid wall ≥ 100 mm - w30 x d15 mm, either side	17
A.1.4.5	Rigid wall ≥ 100 mm - w40 x d20 mm, either side	18
A.1.4.6	Rigid wall ≥ 150 mm - w30 x d15 mm, both sides	19
A.1.4.7	Rigid wall ≥ 150 mm - w50 x d10 mm, either side	20
A.1.5	Rigid wall to rigid wall - Horizontal	21
A.1.5.1	Rigid wall ≥ 150 mm - w40 x d15 mm, both sides	21
A.1.5.2	Rigid wall ≥ 150 mm - w40 x d15 mm, non-fire side	22
A.1.5.3	Rigid wall ≥ 150 mm - w100 x d10 mm, non-fire side	23
A.1.5.4	Rigid wall ≥ 150 mm - w100 x d10 mm, both sides	24
A.1.6	Rigid wall - Wooden frame	25
A.1.6.1	Rigid wall ≥ 100 mm - Wooden frame - w15 x d10 mm, fire side	25
A.1.6.2	Rigid wall ≥ 100 mm - Wooden frame - w20 x d10 mm, both sides	26
A.1.7	Rigid wall to rigid floor	27
A.1.7.1	Rigid wall ≥ 100 mm - Rigid floor ≥ 150 mm - w15 x d10 mm, both sides	27
A.1.7.2	Rigid wall ≥ 100 mm - Rigid floor ≥ 150 mm - w15 x d10 mm, either side	28
A.1.7.3	Rigid wall ≥ 100 mm - Rigid floor ≥ 150 mm - w30 x d15 mm, both sides	29
A.1.7.4	Rigid wall ≥ 100 mm - Rigid floor ≥ 150 mm - w30 x d15 mm, either side	30
A.1.7.5	Rigid wall ≥ 150 mm - Rigid floor ≥ 150 mm - w30 x d15 mm, both sides	31
A.1.7.6	Rigid wall ≥ 150 mm - Rigid floor ≥ 150 mm - w50 x d10 mm, either side	32
A.1.8	Rigid wall to steel deck floor	33
A.1.8.1	Rigid wall ≥ 100 mm - Steel deck floor ≥ 150 mm - w30 x d15 mm, both sides	33
A.1.9	Rigid floor to rigid floor	34
A.1.9.1	Rigid floor ≥ 150 mm - w40 x d15 mm, both sides	34
A.1.9.2	Rigid floor ≥ 150 mm - w40 x d15 mm, top of floor	35
A.1.9.3	Rigid floor ≥ 150 mm - w100 x d10 mm, top of floor	36
A.1.9.4	Rigid floor ≥ 150 mm - w100 x d10 mm, both sides	37

A.1.1 Flexible wall - Wooden frame

A.1.1.1 Flexible wall ≥ 100 mm - Wooden frame - w15 x d10 mm, either side

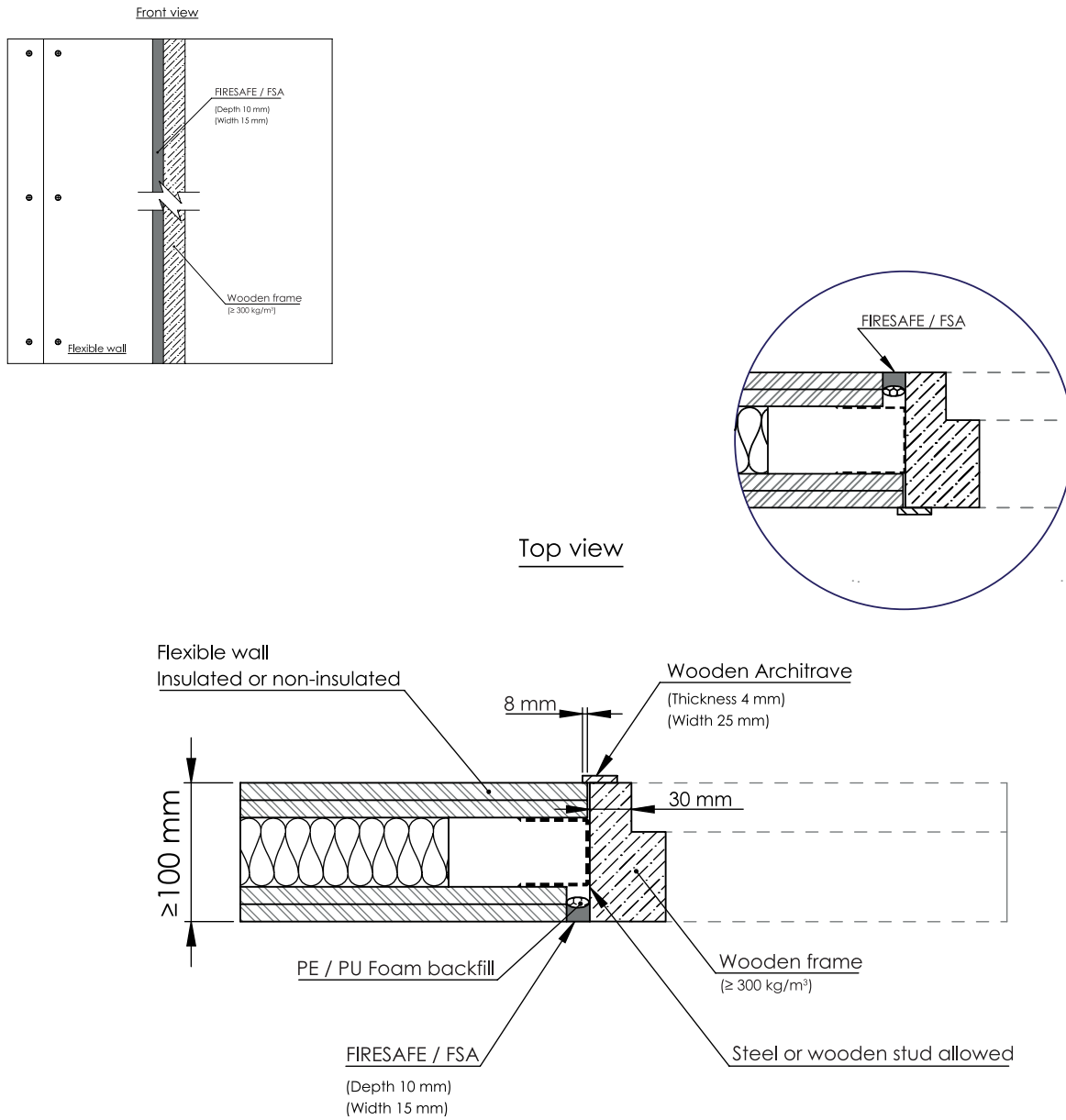

Drawing: FW-W.E-MSP1.2.2.12

Construction	Width (mm)	Depth (mm)	Backing	Position	Classification
Flexible wall - Wooden frame	≤ 15	≥ 10	PE / PU Foam	Either side	EI 90 - V - X - F - W00 to W15

A.1.1 Flexible wall - Wooden frame

A.1.1.2 Flexible wall ≥ 100 mm - Wooden frame - w30 x d10 mm, both sides

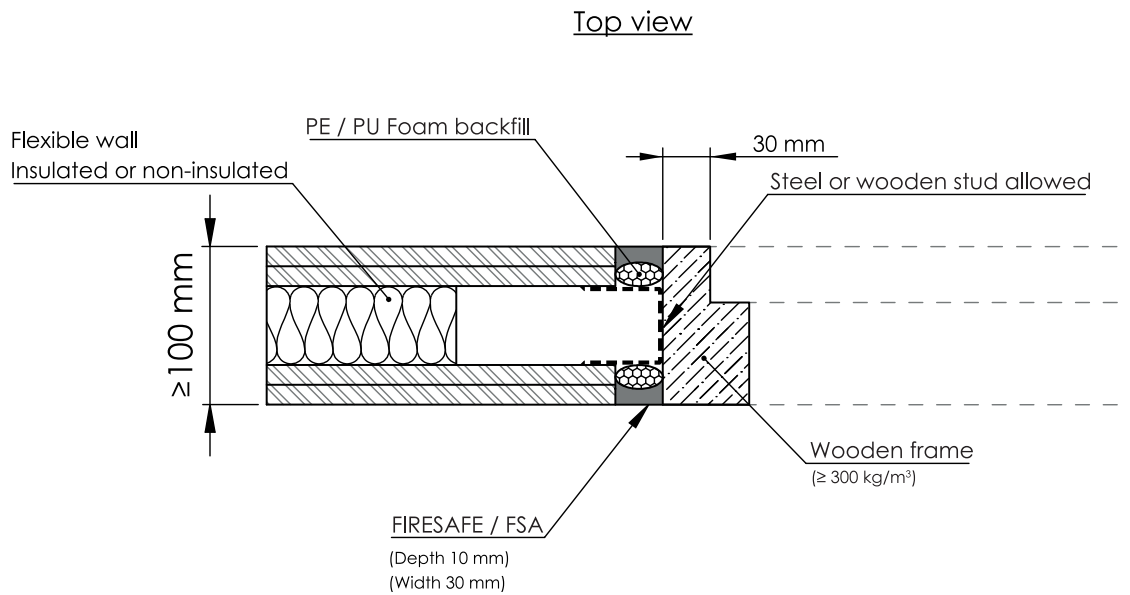
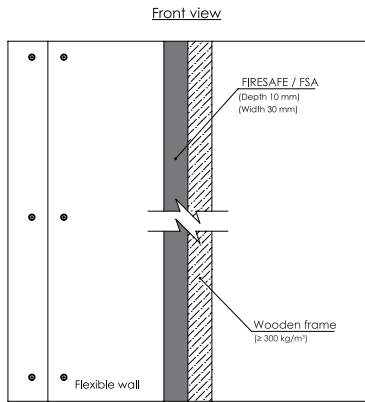

Drawing: FW-W,E-MSP2.2.2.15.2

Construction	Width (mm)	Depth (mm)	Backing	Position	Classification
Flexible wall - Wooden frame	≤ 30	≥ 10	PE / PU Foam	Both sides	EI 90 - V - X - F - W00 to W30

A.1.2 Flexible wall to rigid wall - Vertical

A.1.2.1 Flexible wall ≥ 100 mm - Rigid wall ≥ 100 mm - w15 x d12.5 mm, both sides

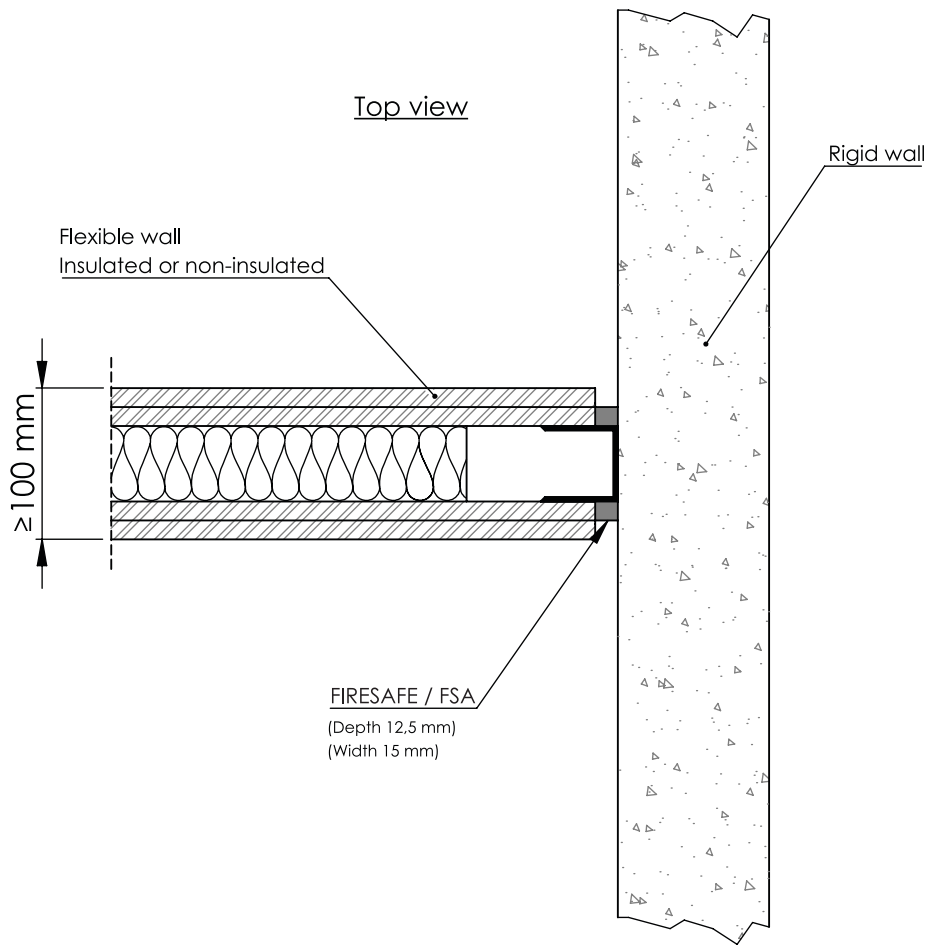
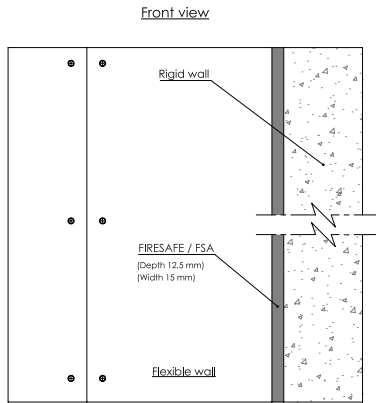

Drawing: FW-RW.E-MSP2.2.2.22

Construction	Width (mm)	Depth (mm)	Backing	Position	Classification
Flexible wall to rigid wall	≤ 15	≥ 12.5	Steel stud	Both sides	EI 90, E 180 - V - X - F - W00 to W15

A.1.2 Flexible wall to rigid wall - Vertical

A.1.2.2 Flexible wall ≥ 100 mm - Rigid wall ≥ 100 mm - w15 x d25 mm, both sides

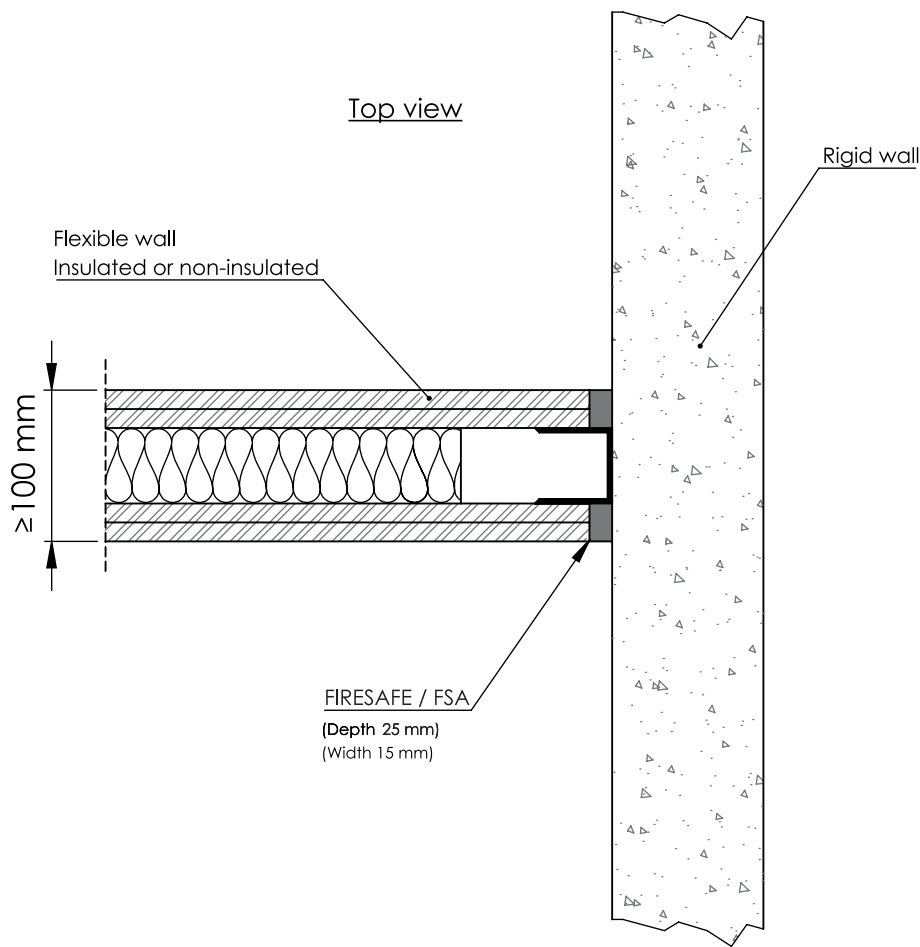
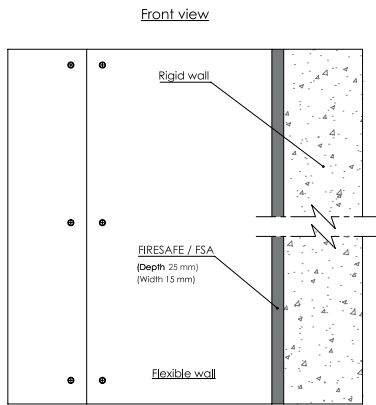

Drawing: FW-RW,E-MSP2.2.2.42

Construction	Width (mm)	Depth (mm)	Backing	Position	Classification
Flexible wall to rigid wall	≤ 15	≥ 25	Steel stud	Both sides	EI 90, E 180 - V - X - F - W00 to W15

A.1.2 Flexible wall to rigid wall - Vertical

A.1.2.3 Flexible wall ≥ 100 mm - Rigid wall ≥ 100 mm - w30 x d12.5 mm, both sides

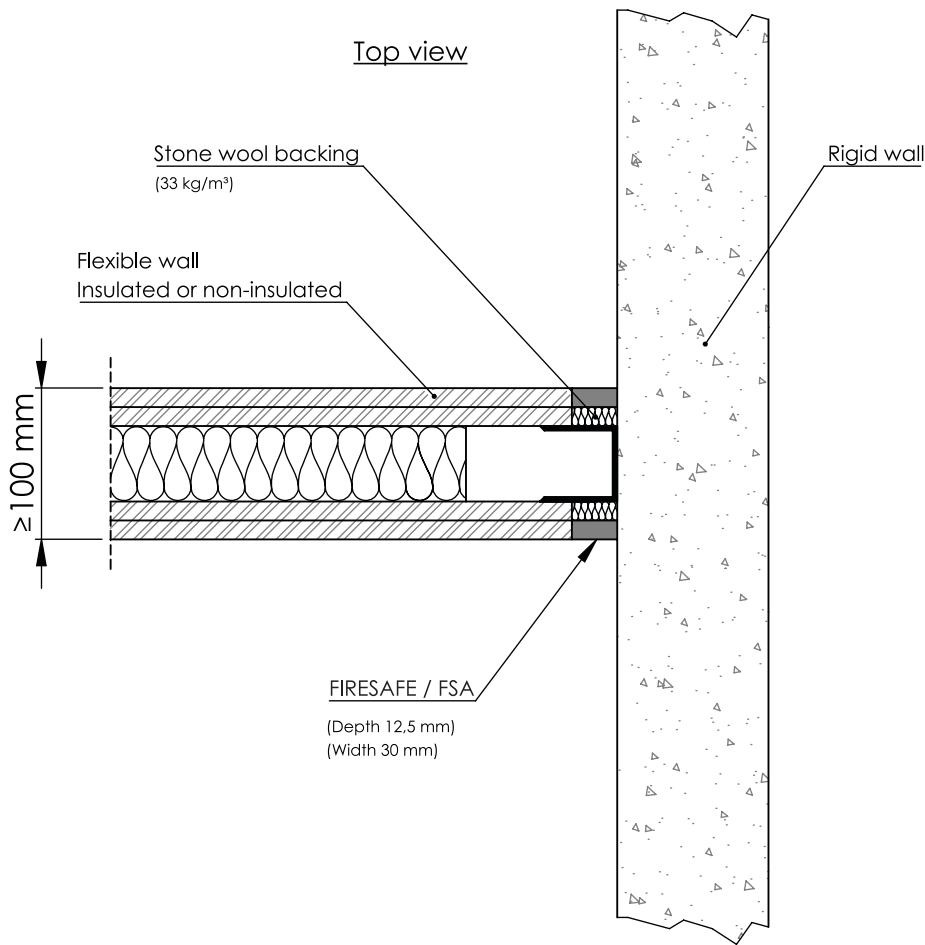
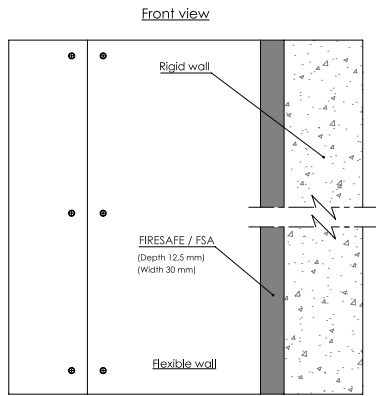

Drawing: FW-RW.E-MSP2.2.25.1

Construction	Width (mm)	Depth (mm)	Backing	Position	Classification
Flexible wall to rigid wall	≤ 30	≥ 12.5	≥ 12.5 mm stone wool (≥ 33 kg/m ³) Steel stud	Both sides	EI 120, E 180 - V - X - F - W00 to W30

A.1.3 Flexible wall to rigid floor - Horizontal

A.1.3.1 Flexible wall ≥ 100 mm - Rigid floor ≥ 150 mm - w30 x 12.5 mm, both sides

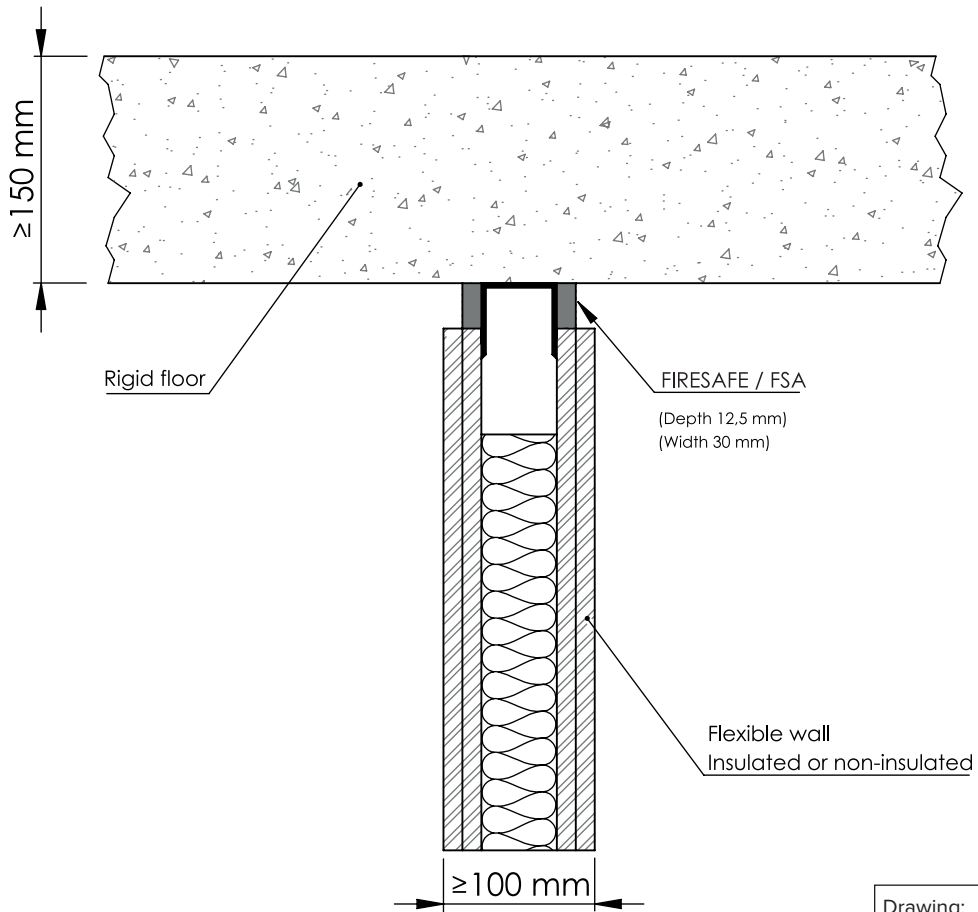
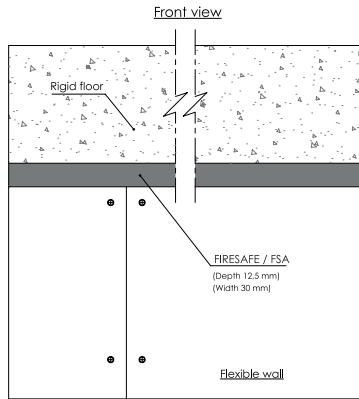

Drawing: FW-RF.E-MSP2.1.2.25

Construction	Width (mm)	Depth (mm)	Backing	Position	Classification
Flexible wall to rigid floor	≤ 30	≥ 12.5	Steel head track	Both sides	EI 120, E 180 - T - X - F - W00 to W30

A.1.3 Flexible wall to rigid floor - Horizontal

A.1.3.2 Flexible wall ≥ 100 mm - Rigid floor ≥ 150 mm - w30 x 25 mm, both sides

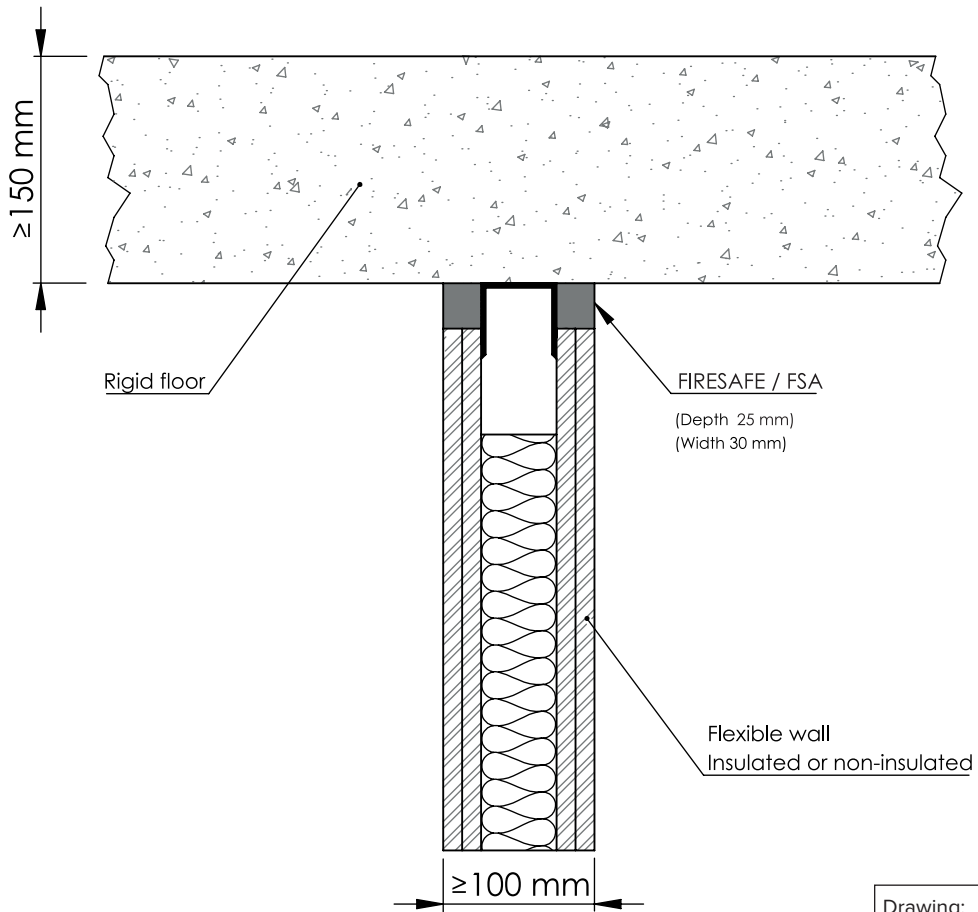
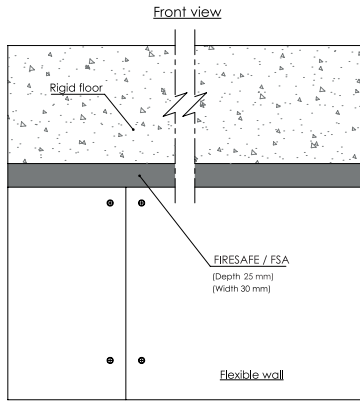

Drawing: FW-RF,E-MSP2.1.2.45

Construction	Width (mm)	Depth (mm)	Backing	Position	Classification
Flexible wall to rigid floor	≤ 30	≥ 25	Steel head track	Both sides	EI 120, E 180 - T - X - F - W00 to W30

A.1.3 Flexible wall to rigid floor - Horizontal

A.1.3.3 Flexible wall ≥ 100 mm - Rigid floor ≥ 150 mm - w30 x d12.5 mm, both sides

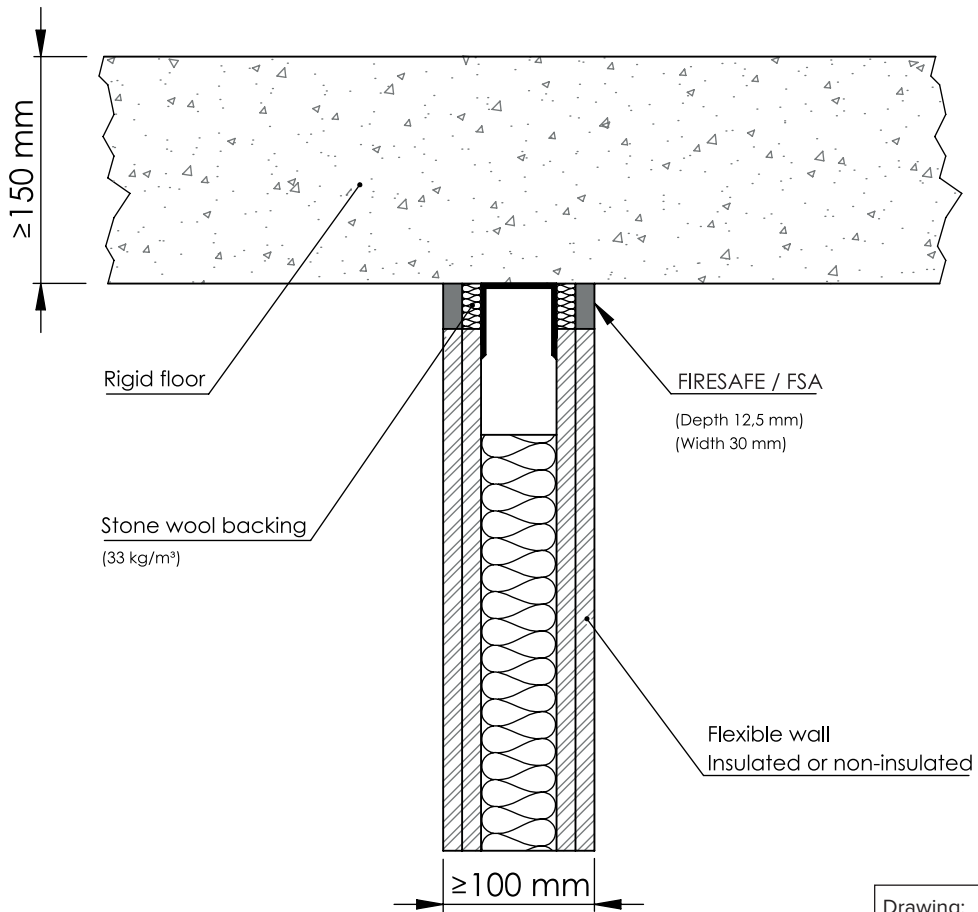
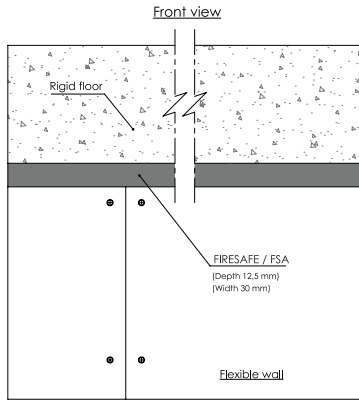

Drawing: FW-RF.E-MSP2.1.2.25.1

Construction	Width (mm)	Depth (mm)	Backing	Position	Classification
Flexible wall to rigid floor	≤ 30	≥ 12.5	≥ 12.5 mm stone wool (≥ 33 kg/m ³) Steel head track	Both sides	EI 120, E 180 - T - X - F - W00 to W30

A.1.4 Rigid wall to rigid wall - Vertical

A.1.4.1 Rigid wall ≥ 100 mm - w15 x d10 mm, both sides

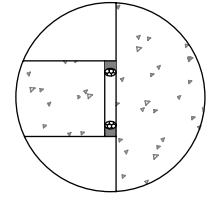
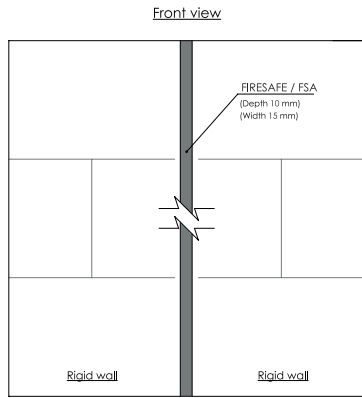

Walls joining perpendicular allowed

Top view

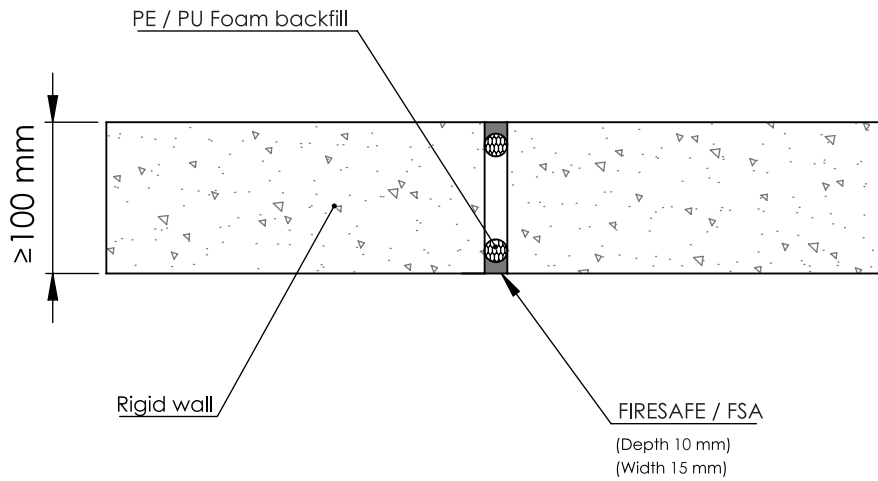

Drawing: RW-RW.E-MSP2.2.2.12.2

Construction	Width (mm)	Depth (mm)	Backing	Position	Classification
Rigid wall to rigid wall	≤ 15	≥ 10	PE / PU Foam	Both sides	EI 180 - V - X - F - W00 to W15

A.1.4 Rigid wall to rigid wall - Vertical

A.1.4.2 Rigid wall ≥ 100 mm - w15 x d10 mm, either side

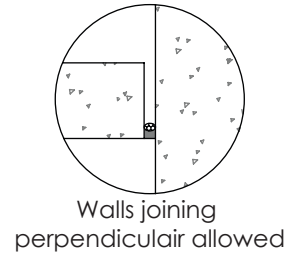
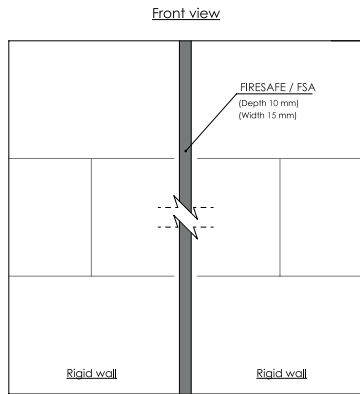

Top view

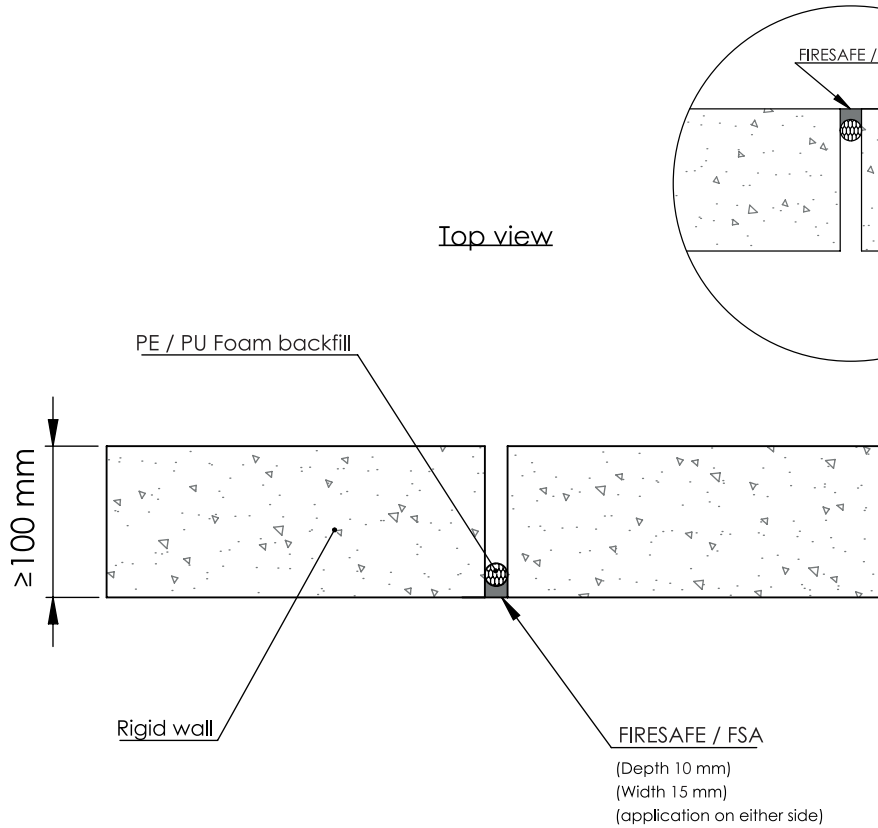

Drawing: RW-RW.E-MSP1.2.2.12.2.1

Construction	Width (mm)	Depth (mm)	Backing	Position	Classification
Rigid wall to rigid wall	≤ 15	≥ 10	PE / PU Foam	Either side	EI 30, E 180 - V - X - F - W00 to W15

A.1.4 Rigid wall to rigid wall - Vertical

A.1.4.3 Rigid wall ≥ 100 mm - w30 x d15 mm, both sides

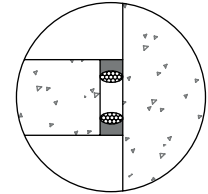
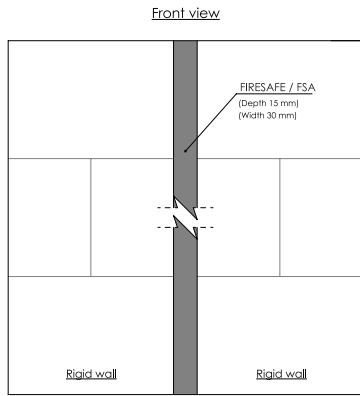

Walls joining perpendicular allowed

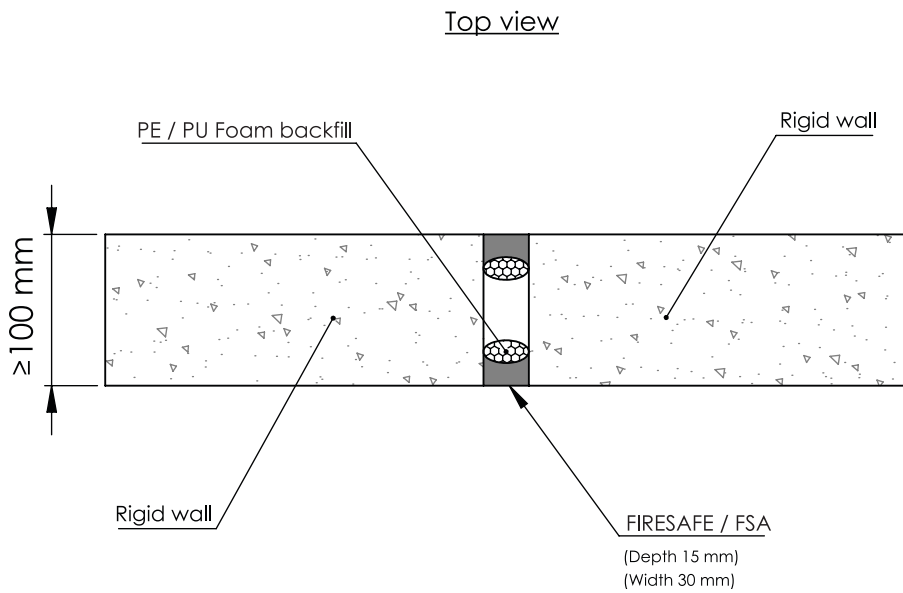

Drawing: RW-RW.E-MSP2.2.2.35

Construction	Width (mm)	Depth (mm)	Backing	Position	Classification
Rigid wall to rigid wall	≤ 30	≥ 15	PE / PU Foam	Both sides	EI 120, E 180 - V - X - F - W00 to W30

A.1.4 Rigid wall to rigid wall - Vertical

A.1.4.4 Rigid wall ≥ 100 mm - w30 x d15 mm, either side

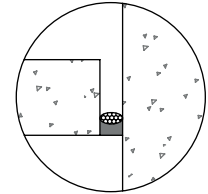
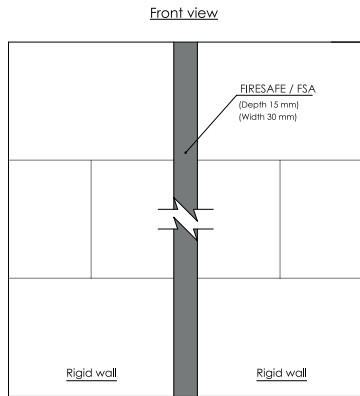

Walls joining perpendicular allowed

Top view

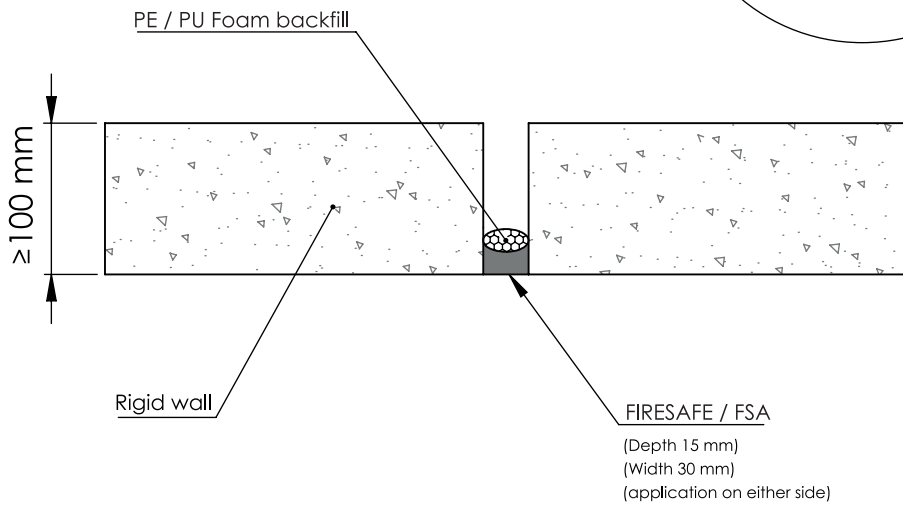
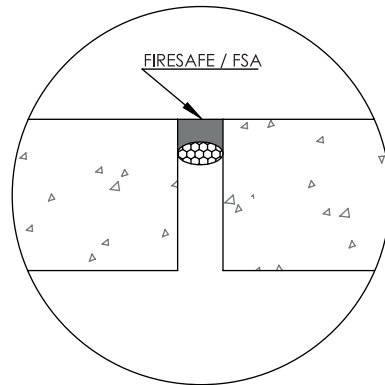

Drawing: RW-RW.E-MSP1.2.2.35

Construction	Width (mm)	Depth (mm)	Backing	Position	Classification
Rigid wall to rigid wall	≤ 30	≥ 15	PE / PU Foam	Either side	EI 60, E 180 - V - X - F - W00 to W30

A.1.4 Rigid wall to rigid wall - Vertical

A.1.4.5 Rigid wall ≥ 100 mm - w40 x d20 mm, either side

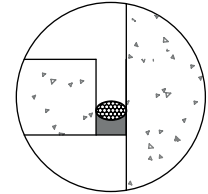
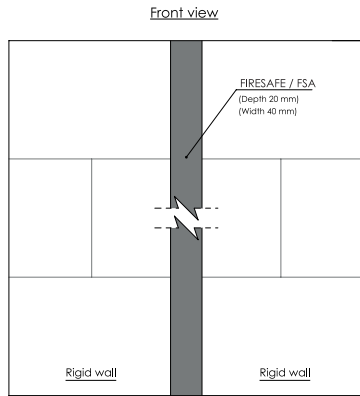

Walls joining perpendicular allowed

Top view

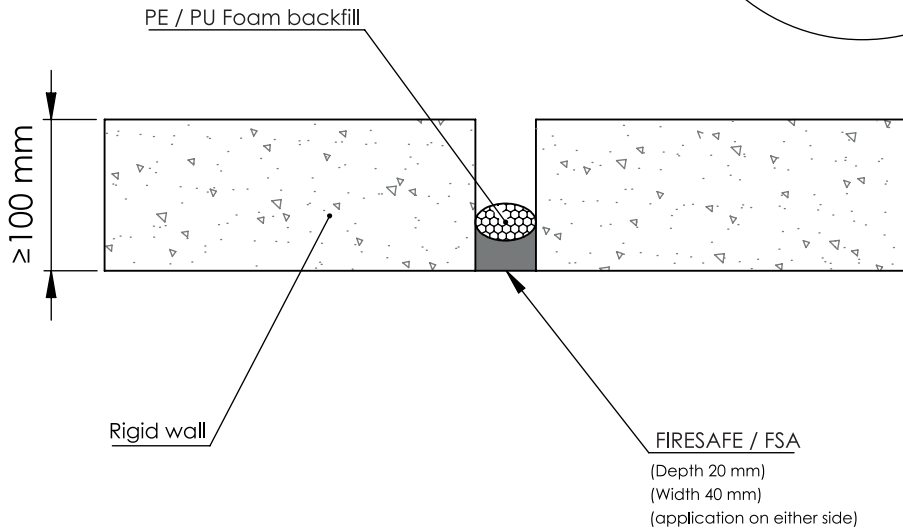
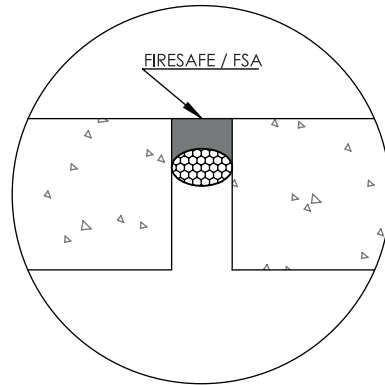

Drawing: RW-RW.E-MSP1.2.2.46

Construction	Width (mm)	Depth (mm)	Backing	Position	Classification
Rigid wall to rigid wall	≤ 40	≥ 20	PE / PU Foam	Either side	EI 30, E 180 - V - X - F - W00 to W40

A.1.4 Rigid wall to rigid wall - Vertical

A.1.4.6 Rigid wall ≥ 150 mm - w30 x d15 mm, both sides

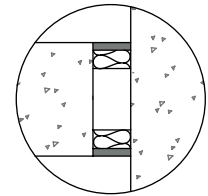
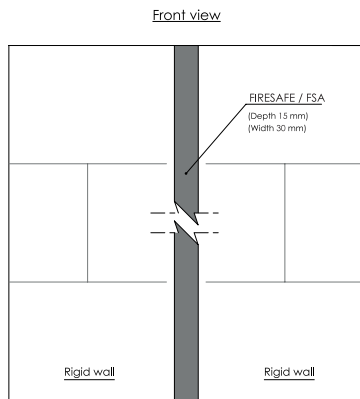

Walls joining perpendicular allowed

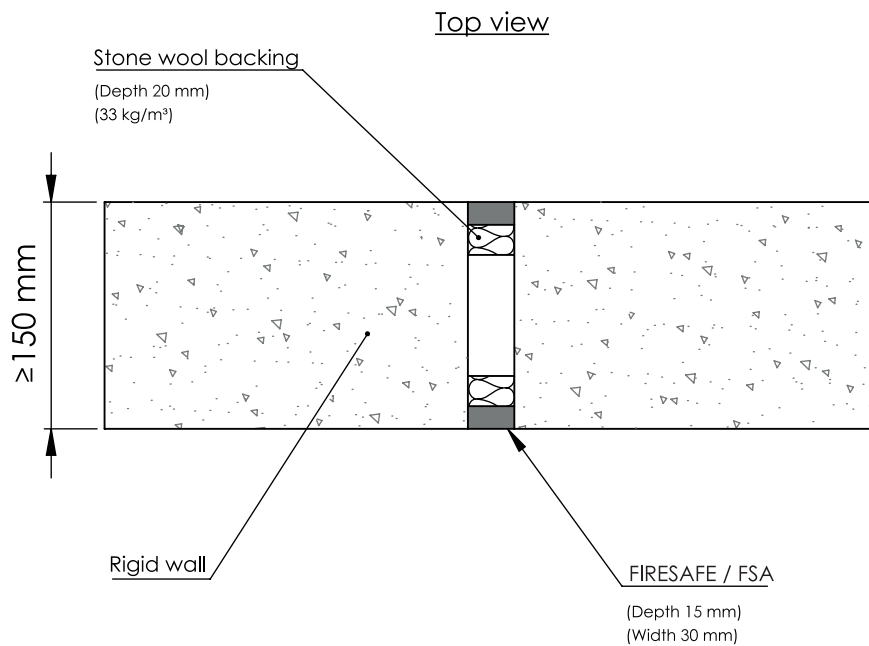

Drawing: RW-RW.E-MSP2.2.2.35.1

Construction	Width (mm)	Depth (mm)	Backing	Position	Classification
Rigid wall to rigid wall	≤ 30	≥ 15	≥ 20 mm stone wool (≥ 33 kg/m ³)	Both sides	EI 240 - V - X - F - W00 to W30

A.1.4 Rigid wall to rigid wall - Vertical

A.1.4.7 Rigid wall ≥ 150 mm - w50 x d10 mm, either side

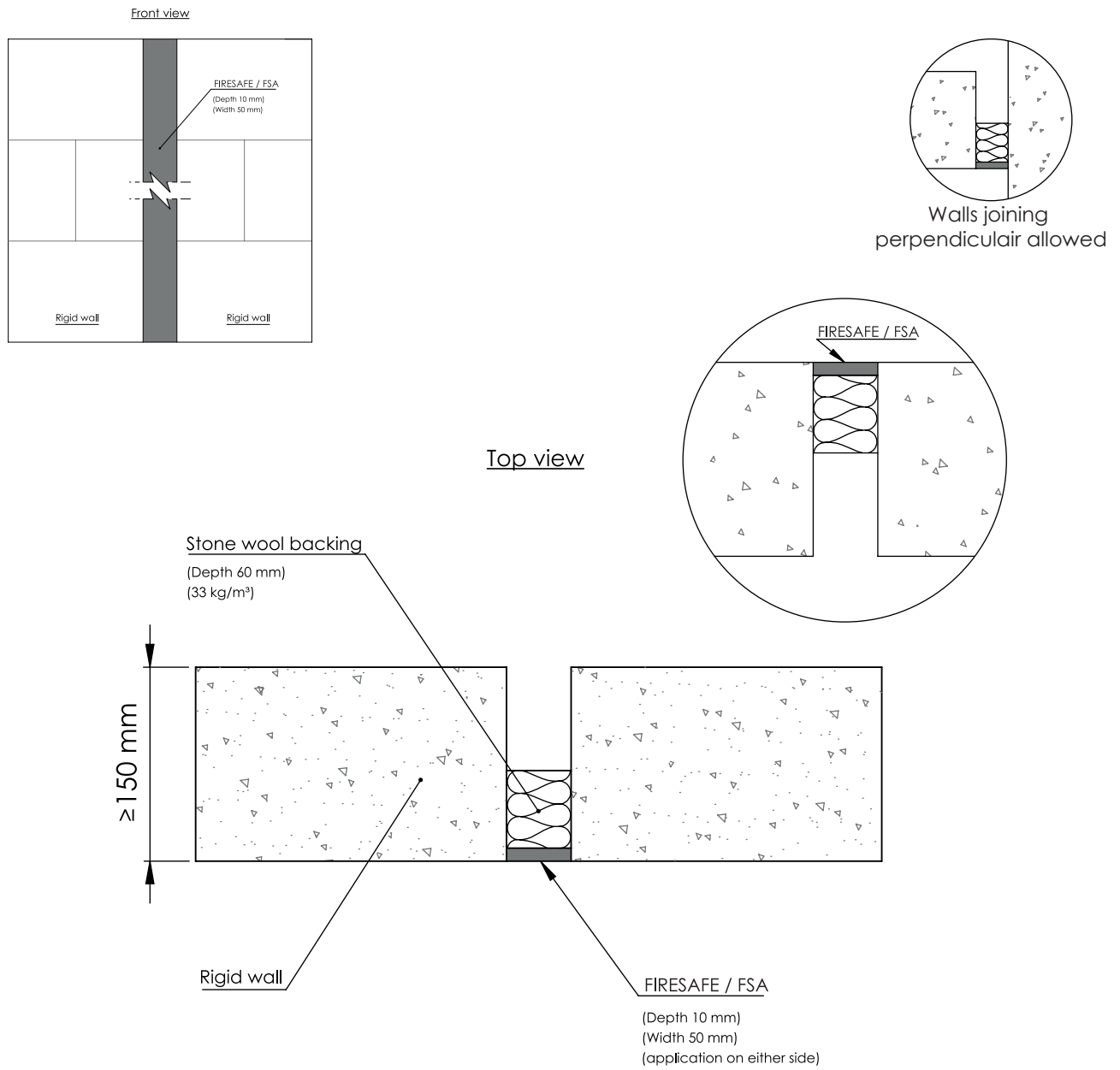

Drawing: RW-RW.E-MSP1.2.2.17.1

Construction	Width (mm)	Depth (mm)	Backing	Position	Classification
Rigid wall to rigid wall	≤ 50	≥ 10	≥ 60 mm stone wool (≥ 33 kg/m ³)	Either side	EI 120, E 180 - V - X - F - W00 to W50

A.1.5 Rigid wall to rigid wall - Horizontal

A.1.5.1 Rigid wall ≥ 150 mm - w40 x d15 mm, both sides

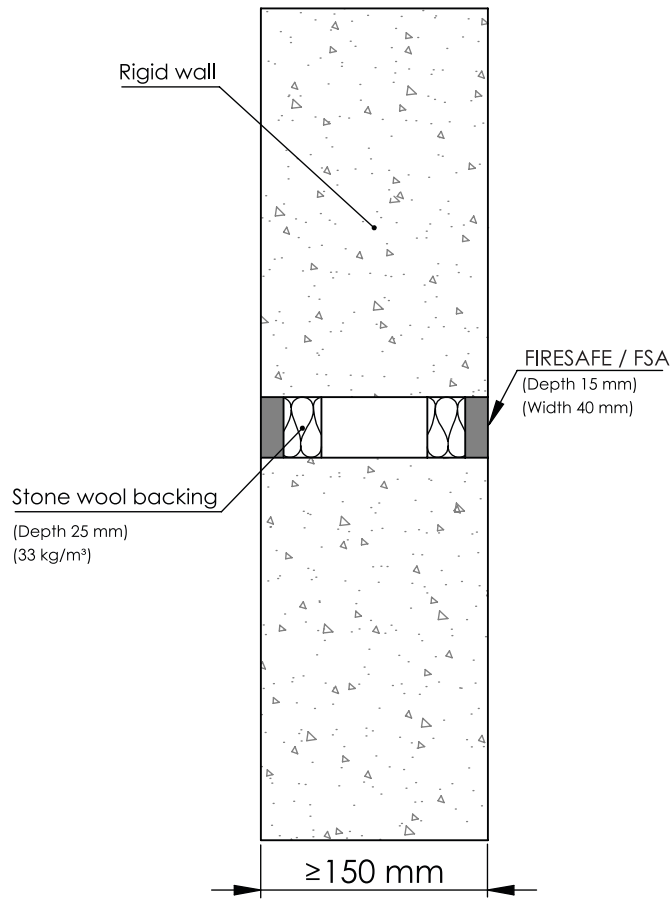
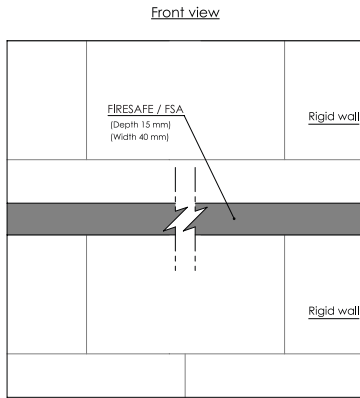

Drawing: RW-RW,E-MSP2.2.36

Construction	Width (mm)	Depth (mm)	Backing	Position	Classification
Rigid wall to rigid wall	≤ 40	≥ 15	≥ 25 mm stone wool (≥ 33 kg/m ³)	Both sides	EI 240 - T - X - F - W00 to W40

A.1.5 Rigid wall to rigid wall - Horizontal

A.1.5.2 Rigid wall ≥ 150 mm - w40 x d15 mm, non-fire side

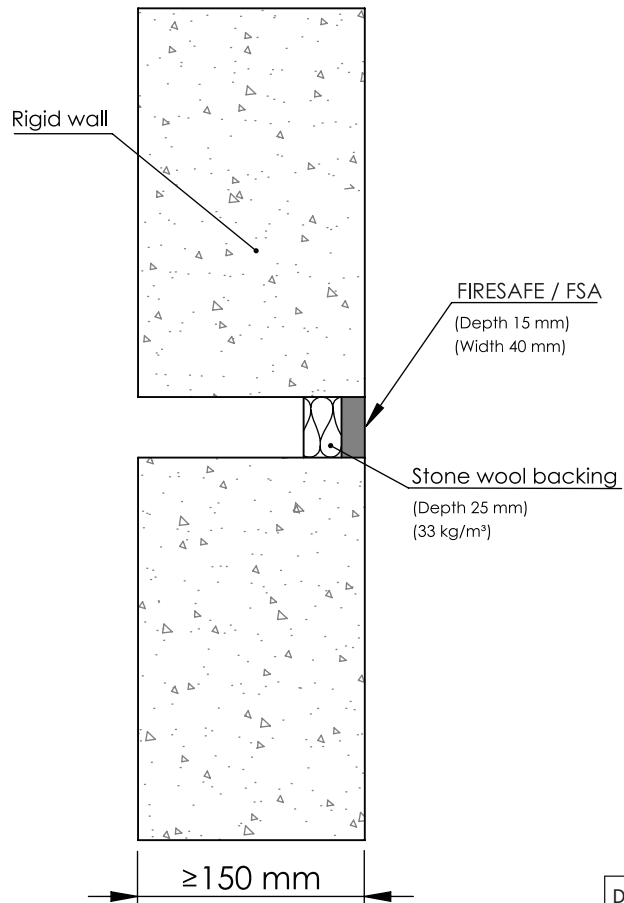
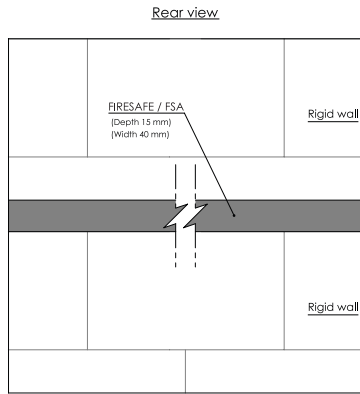

Drawing: RW-RW.E-MSP1.2.36

Construction	Width (mm)	Depth (mm)	Backing	Position	Classification
Rigid wall to rigid wall	≤ 40	≥ 15	≥ 25 mm stone wool (≥ 33 kg/m ³)	Unexposed side	EI 240 - T - X - F - W00 to W40

A.1.5 Rigid wall to rigid wall - Horizontal

A.1.5.3 Rigid wall ≥ 150 mm - w100 x d10 mm, non-fire side

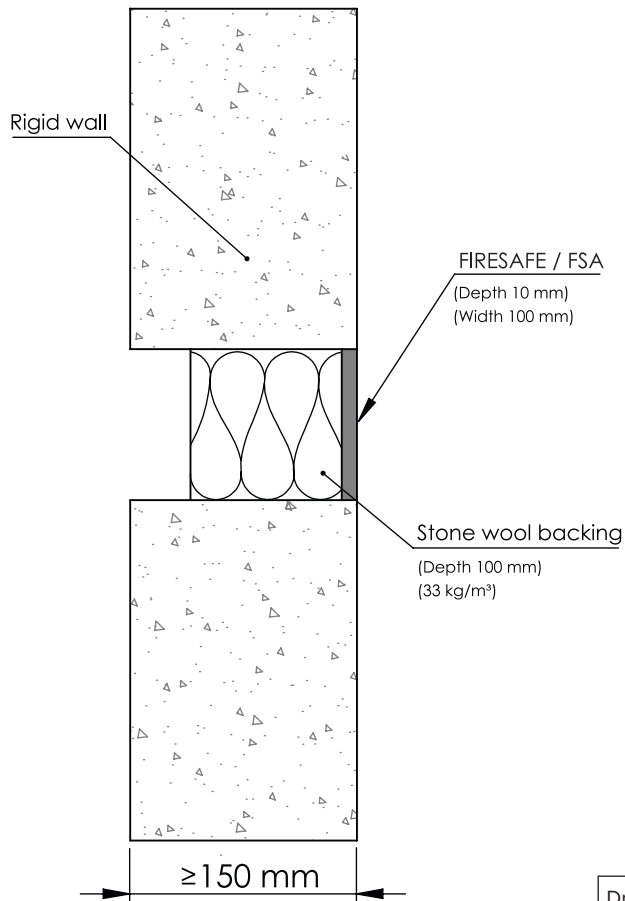
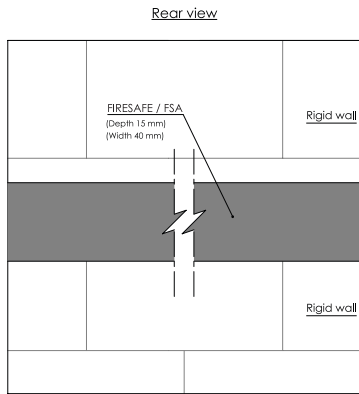

Drawing: RW-RW.E-MSP1.2.18

Construction	Width (mm)	Depth (mm)	Backing	Position	Classification
Rigid wall to rigid wall	≤ 100	≥ 10	≥ 100 mm stone wool (≥ 33 kg/m ³)	Unexposed side	EI 240 - T - X - F - W00 to W100

A.1.5 Rigid wall to rigid wall - Horizontal

A.1.5.4 Rigid wall ≥ 150 mm - w100 x d10 mm, both sides

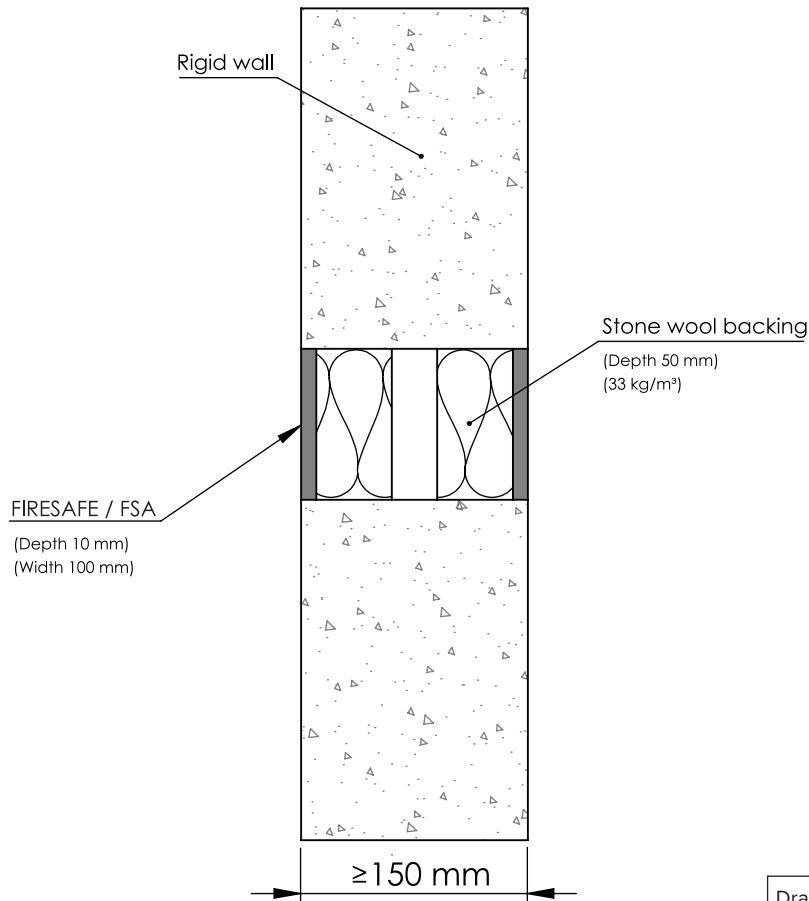
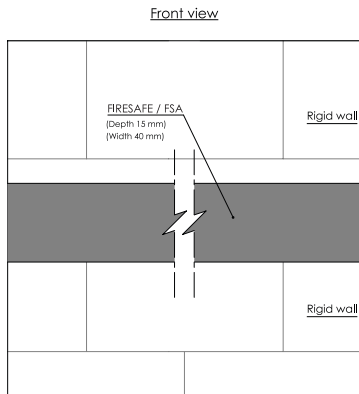

Drawing: RW-RW.E-MSP2.4.18

Construction	Width (mm)	Depth (mm)	Backing	Position	Classification
Rigid wall to rigid wall	≤ 100	≥ 10	≥ 50 mm stone wool (≥ 33 kg/m ³)	Both sides	EI 240 - T - X - F - W00 to W100

A.1.6 Rigid wall - Wooden frame

A.1.6.1 Rigid wall ≥ 100 mm - Wooden frame - w15 x d10 mm, either side

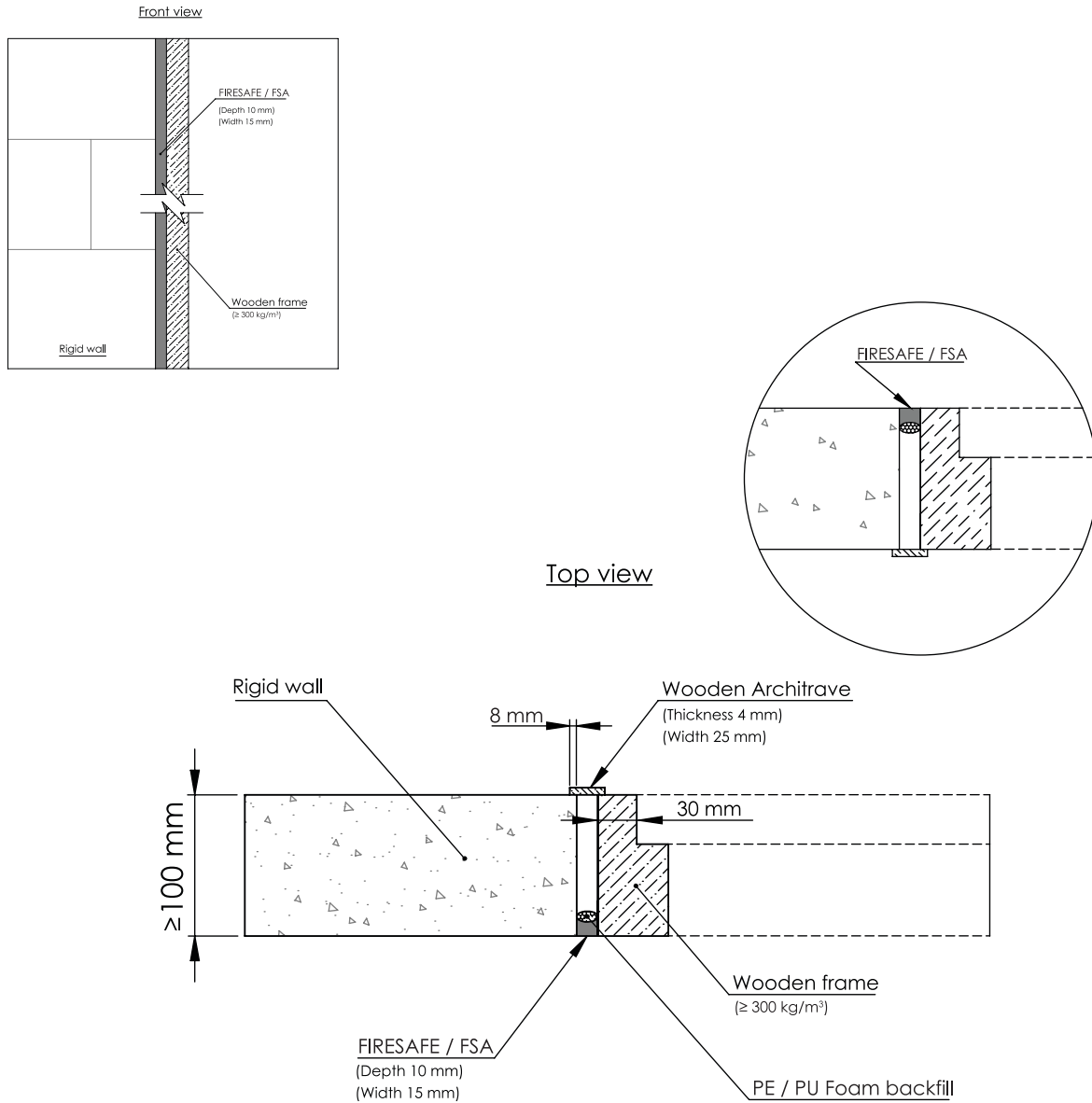

Drawing: RW-W.E-MSP1.2.12

Construction	Width (mm)	Depth (mm)	Backing	Position	Classification
Rigid wall - Wooden frame	≤ 15	≥ 10	PE / PU Foam	Either side	EI 90 - V - X - F - W00 to W15

A.1.6 Rigid wall - Wooden frame

A.1.6.2 Rigid wall ≥ 100 mm - Wooden frame - w20 x d10 mm, both sides

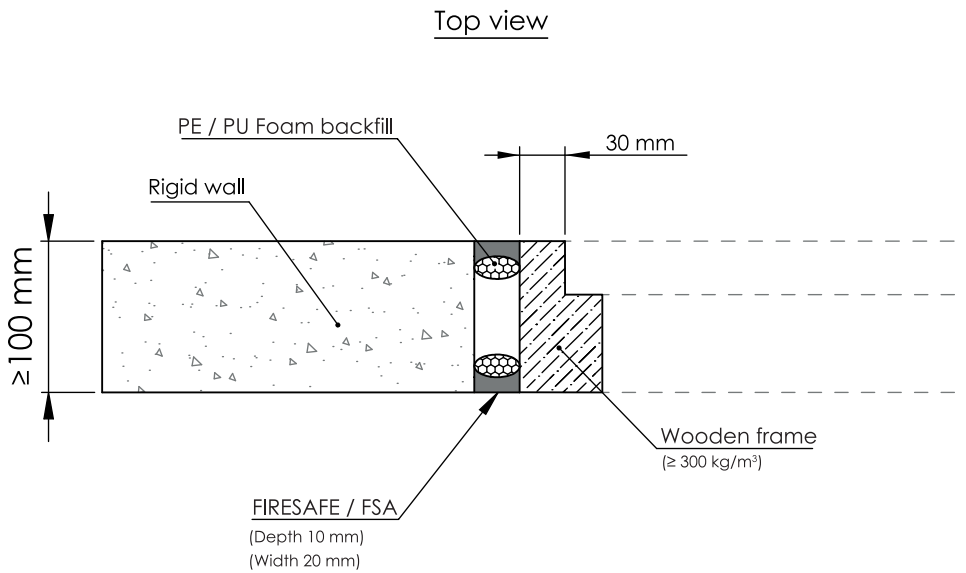
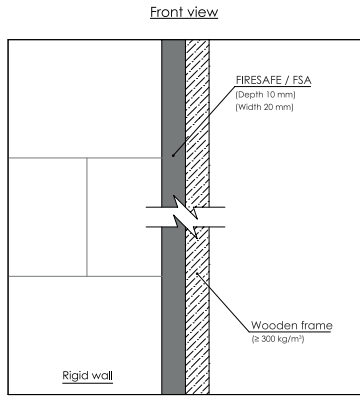

Drawing: RW-W,E-MSP2.2.2.15

Construction	Width (mm)	Depth (mm)	Backing	Position	Classification
Rigid wall - Wooden frame	≤ 30	≥ 10	PE / PU Foam	Both sides	EI 90 - V - X - F - W00 to W30

A.1.7

Rigid wall to rigid floor

A.1.7.1

Rigid wall ≥ 100 mm - Rigid floor ≥ 150 mm - w15 x d10 mm, both sides

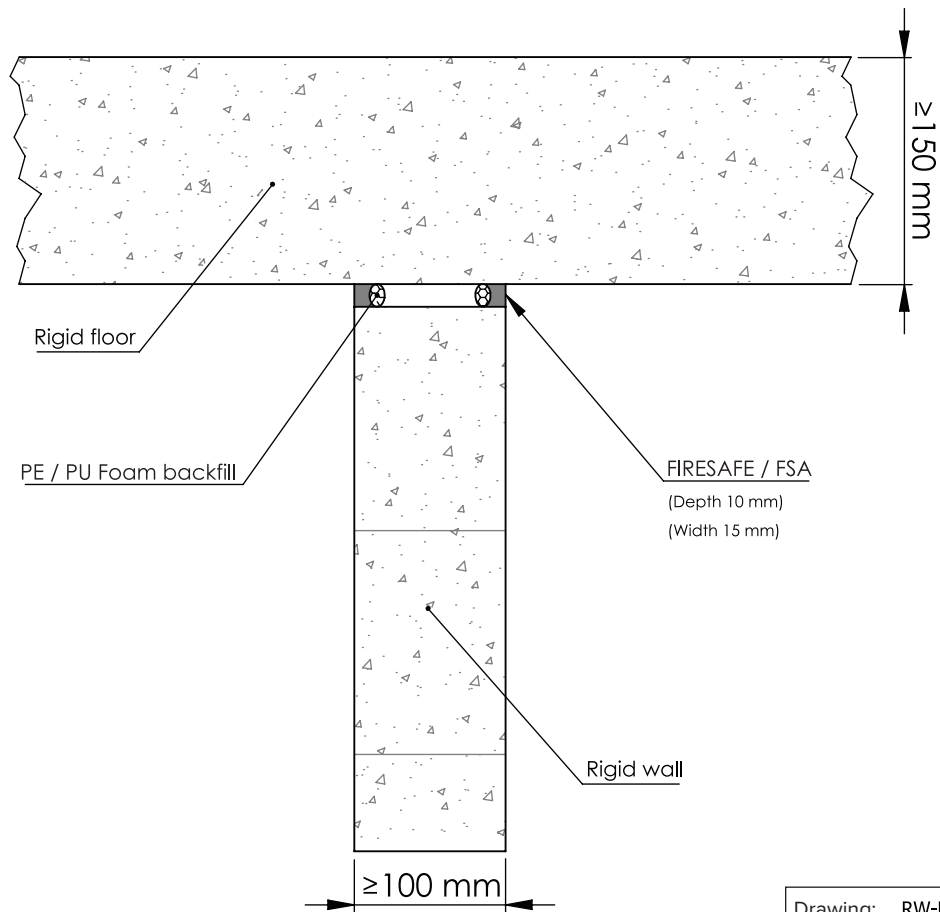
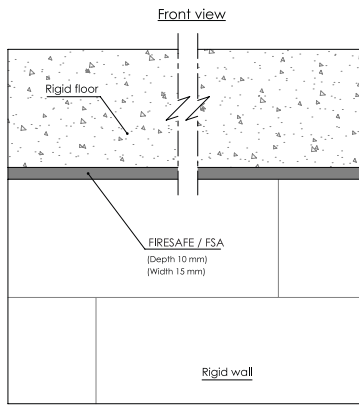

Drawing: RW-RF.E-MSP2.1.2.12

Construction	Width (mm)	Depth (mm)	Backing	Position	Classification
Rigid wall to rigid floor	≤ 15	≥ 10	PE / PU Foam	Both sides	EI 180 - T - X - F - W00 to W15

A.1.7 Rigid wall to rigid floor

A.1.7.2 Rigid wall ≥ 100 mm - Rigid floor ≥ 150 mm - w15 x d10 mm, either side

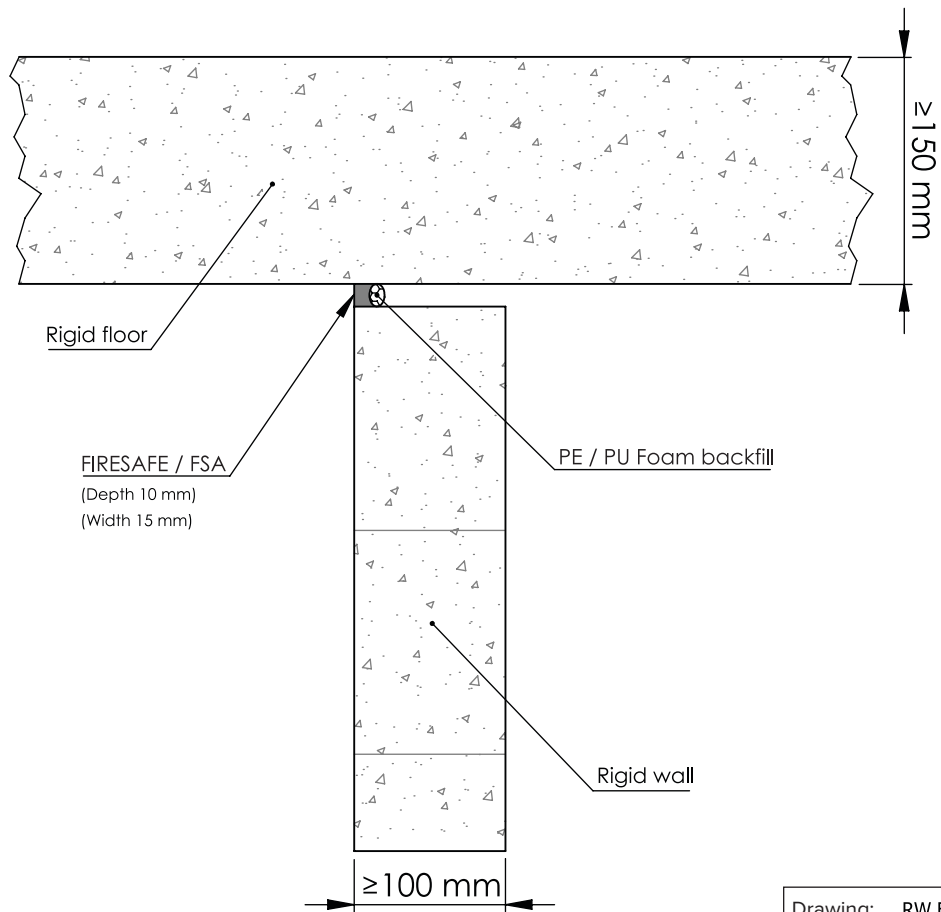
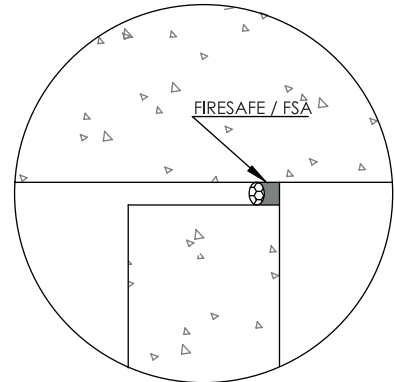
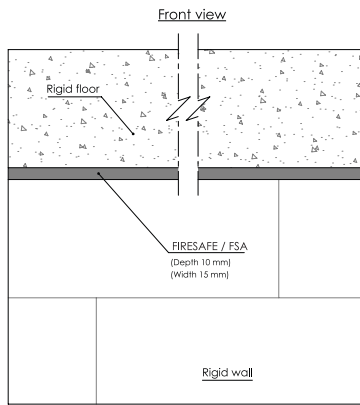

Drawing: RW.E-RF-MSP1.1.2.12

Construction	Width (mm)	Depth (mm)	Backing	Position	Classification
Rigid wall to rigid floor	≤ 15	≥ 10	PE / PU Foam	Either side	EI 30, E 180 - T - X - F - W00 to W15

A.1.7

Rigid wall to rigid floor

A.1.7.3

Rigid wall ≥ 100 mm - Rigid floor ≥ 150 mm - w30 x d15 mm, both sides

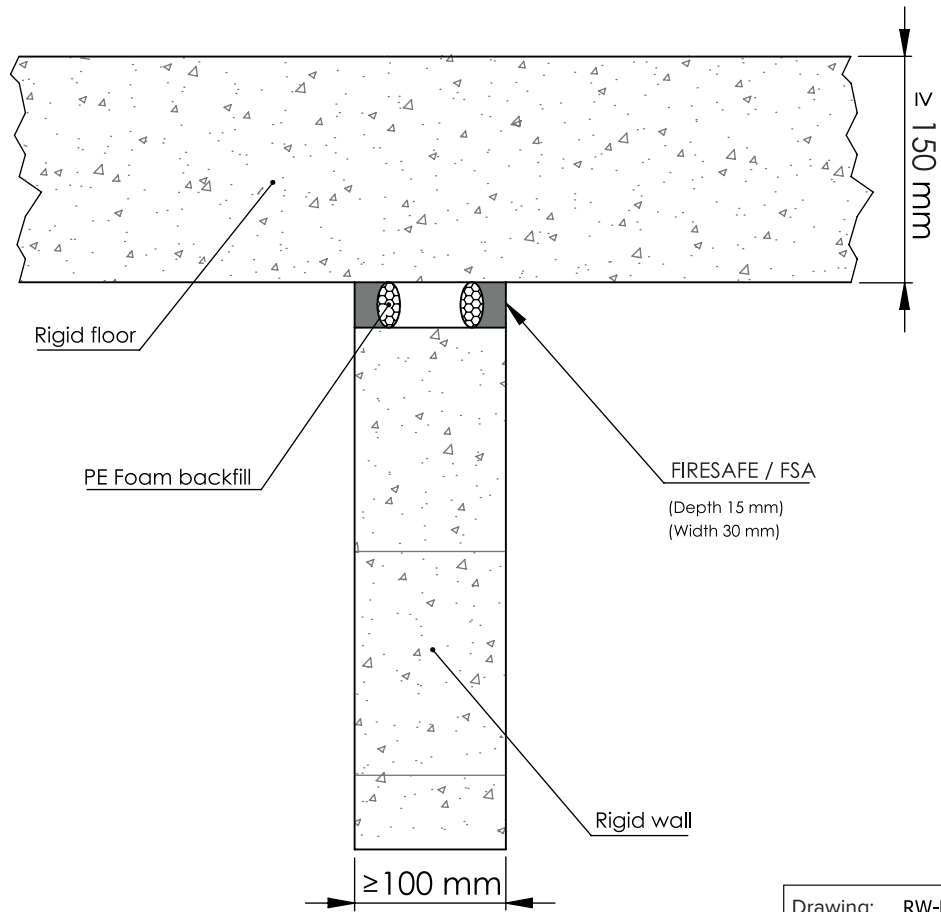
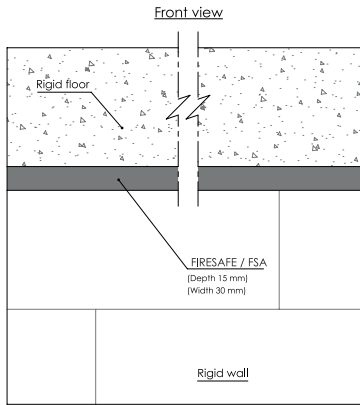

Construction	Width (mm)	Depth (mm)	Backing	Position	Classification
Rigid wall to rigid floor	≤ 30	≥ 15	PE / PU Foam	Both sides	EI 180 - T - X - F - W00 to W30

A.1.7 Rigid wall to rigid floor

A.1.7.4 Rigid wall ≥ 100 mm - Rigid floor ≥ 150 mm - w30 x d15 mm, either side

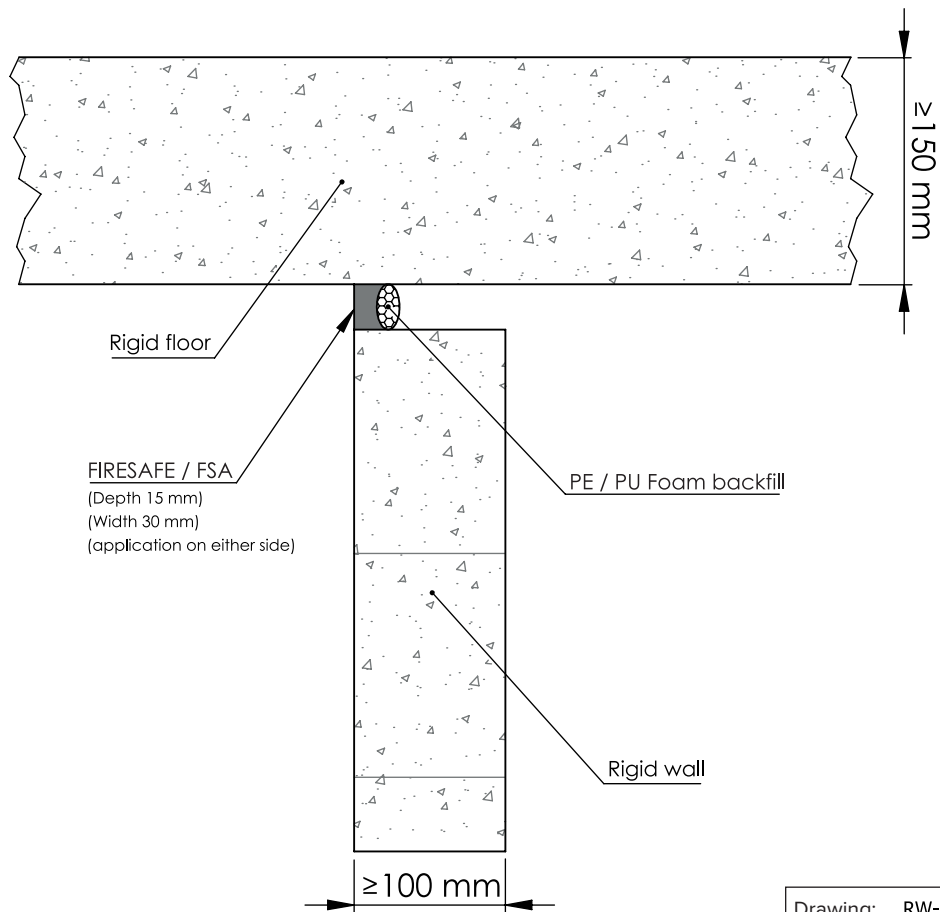
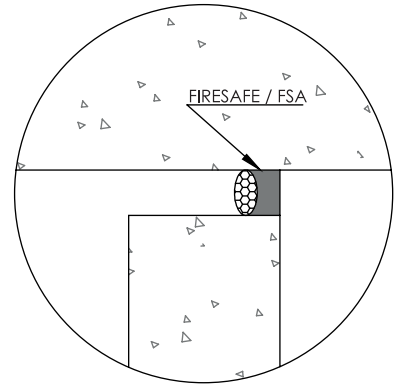
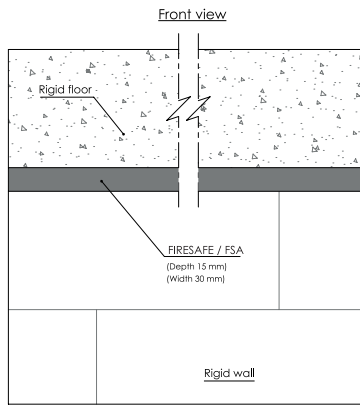

Drawing: RW-RF.E-MSP1.2.2.35

Construction	Width (mm)	Depth (mm)	Backing	Position	Classification
Rigid wall to rigid floor	≤ 30	≥ 15	PE / PU Foam	Either side	EI 60, E 180 - T - X - F - W00 to W30

A.1.7

Rigid wall to rigid floor

A.1.7.5

Rigid wall ≥ 150 mm - Rigid floor ≥ 150 mm - w30 x d15 mm, both sides

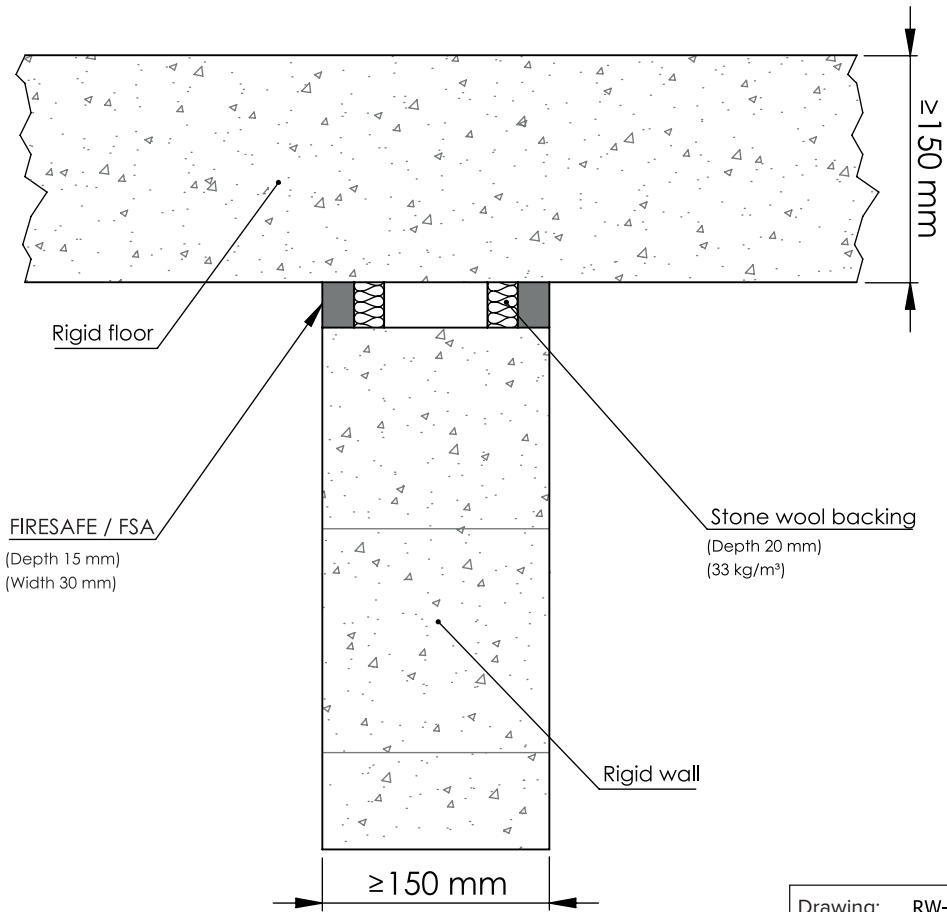
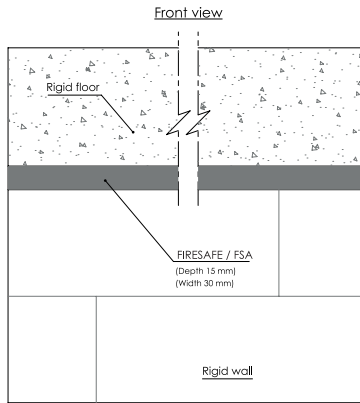

Drawing: RW-RF.E-MSP2.1.35

Construction	Width (mm)	Depth (mm)	Backing	Position	Classification
Rigid wall to rigid floor	≤ 30	≥ 15	≥ 20 mm stone wool (≥ 33 kg/m ³)	Both sides	EI 240 - T - X - F - W00 to W30

A.1.7 Rigid wall to rigid floor

A.1.7.6 Rigid wall ≥ 150 mm - Rigid floor ≥ 150 mm - w50 x d10 mm, either side

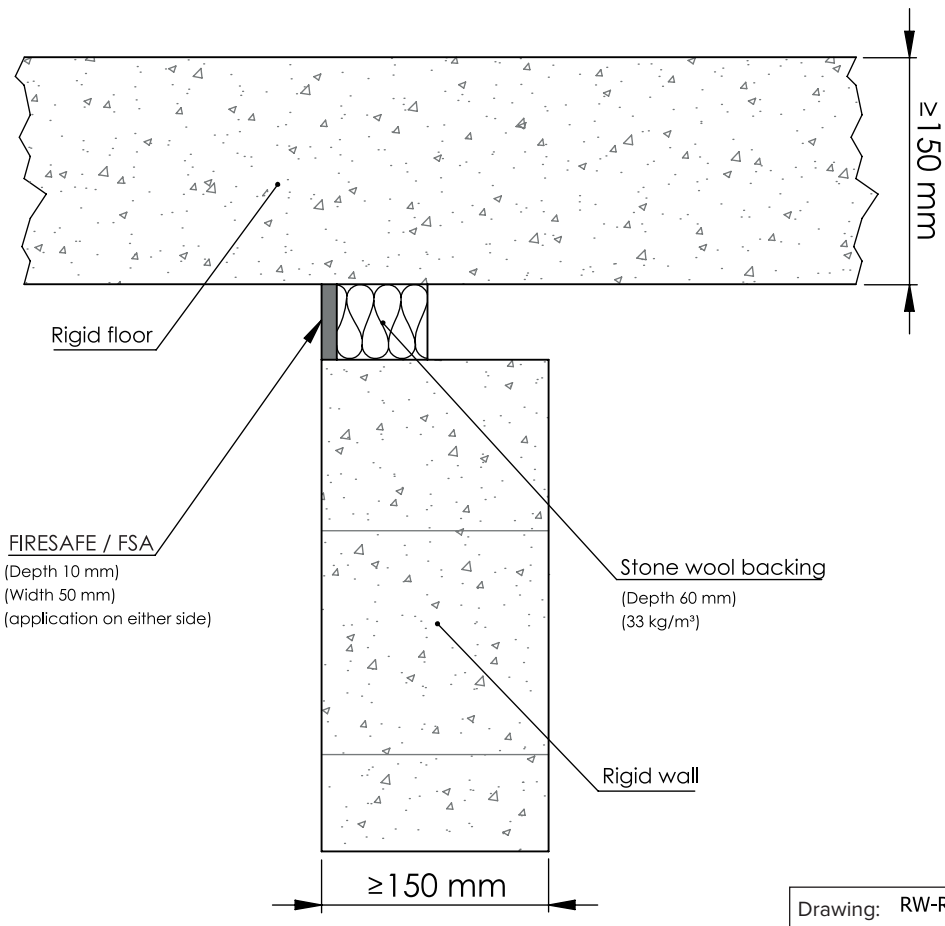
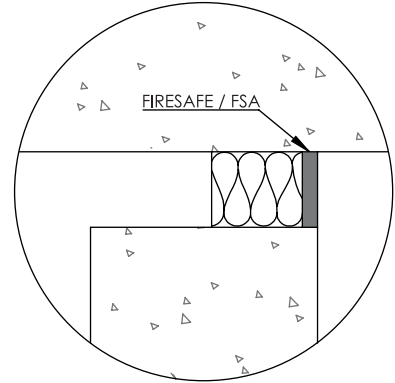
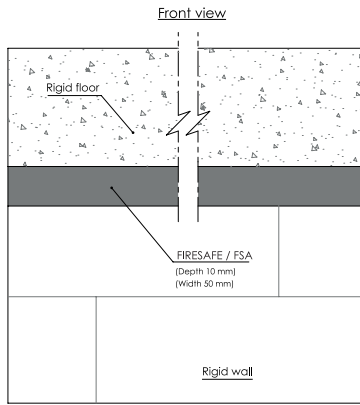

Drawing: RW-RF.E-MSP1.1.2.18

Construction	Width (mm)	Depth (mm)	Backing	Position	Classification
Rigid wall to rigid floor	≤ 50	≥ 10	≥ 60 mm stone wool (≥ 33 kg/m ³)	Either side	EI 180 - T - X - F - W00 to W50

A.1.8 Rigid wall to steel deck floor

A.1.8.1 Rigid wall ≥ 100 mm - Steel deck floor ≥ 150 mm - w30 x d15 mm, both sides

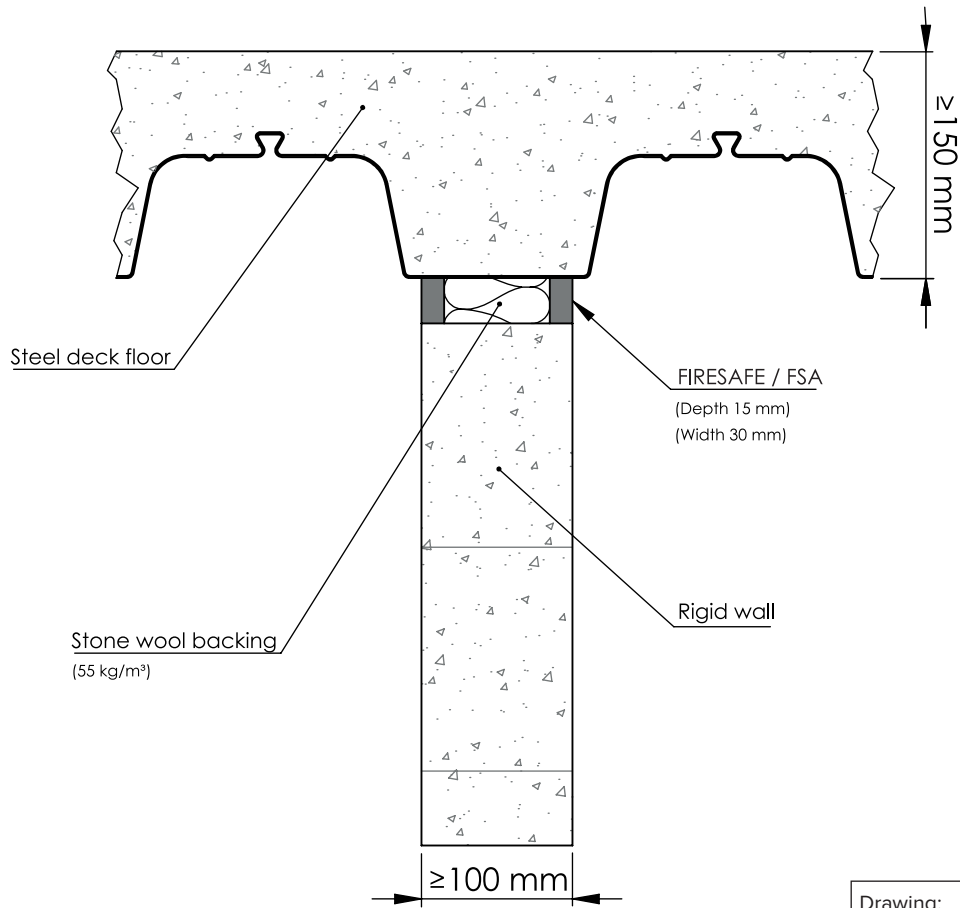
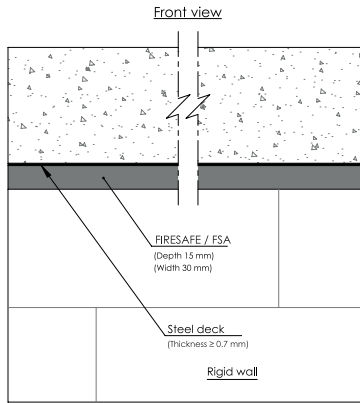

Drawing: RW-RF.E-MSP2.1.2.35S

Construction	Width (mm)	Depth (mm)	Backing	Position	Classification
Rigid wall to steel deck floor	≤ 30	≥ 15	≥ 70 mm stone wool (≥ 55 kg/m ³)	Both sides	EI 120, E 180 - T - X - F - W00 to W30

A.1.9 Rigid floor to rigid floor

A.1.9.1 Rigid floor ≥ 150 mm - w40 x d15 mm, both sides

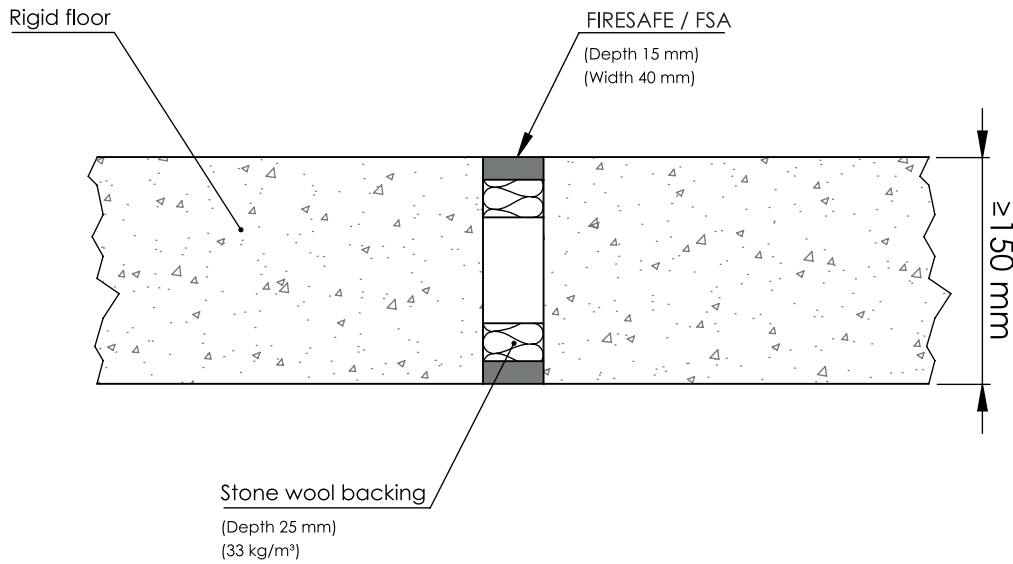
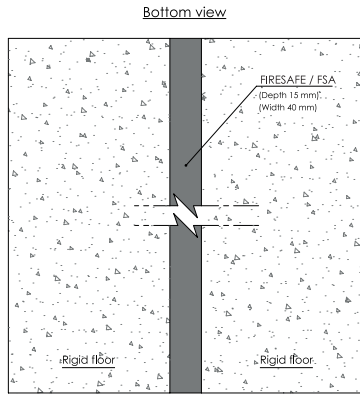

Drawing: RF-RF.E-MSP2.4.2.36

Construction	Width (mm)	Depth (mm)	Backing	Position	Classification
Rigid floor	≤ 40	≥ 15	≥ 25 mm stone wool (≥ 33 kg/m ³)	Both sides	EI 240 - H - X - F - W00 to W40

A.1.9 Rigid floor to rigid floor

A.1.9.2 Rigid floor ≥ 150 mm - w40 x d15 mm, top of floor

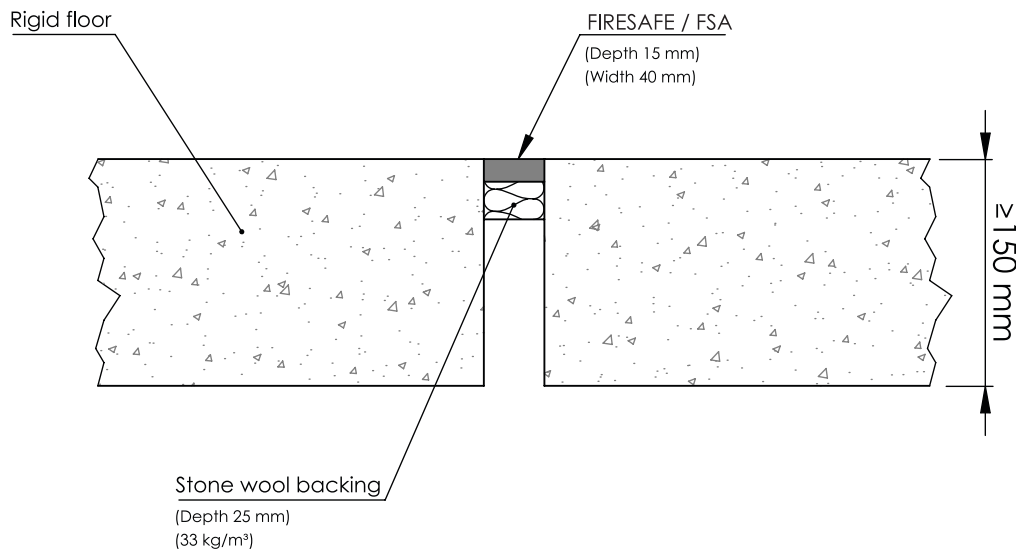
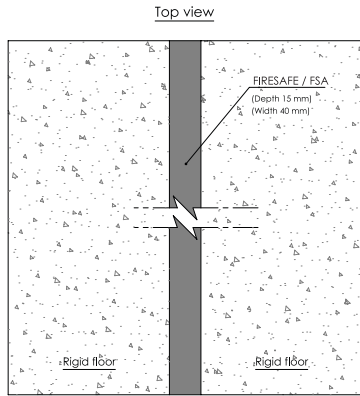

Drawing: RF-RF.E-MSP1.4.1.36

Construction	Width (mm)	Depth (mm)	Backing	Position	Classification
Rigid floor	≤ 40	≥ 15	≥ 25 mm stone wool (≥ 33 kg/m ³)	Top of floor	EI 240 - H - X - F - W00 to W40

A.1.9 Rigid floor to rigid floor

A.1.9.3 Rigid floor ≥ 150 mm - w100 x d10 mm, top of floor

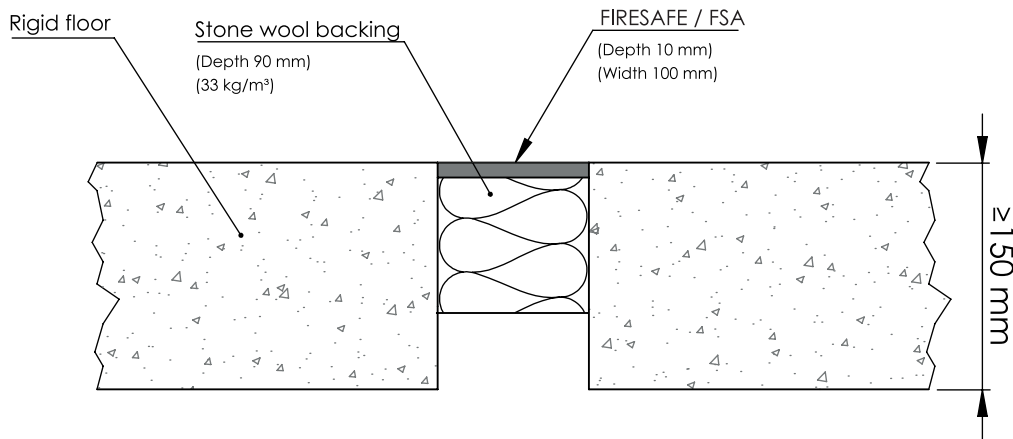
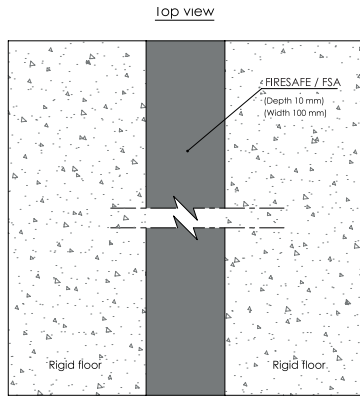

Drawing: RF-RF.E-MSP1.4.18

Construction	Width (mm)	Depth (mm)	Backing	Position	Classification
Rigid floor	≤ 100	≥ 10	≥ 90 mm stone wool (≥ 33 kg/m ³)	Top of floor	EI 240 - H - X - F - W00 to W100

A.1.9 Rigid floor to rigid floor

A.1.9.4 Rigid floor ≥ 150 mm - w100 x d10 mm, both sides

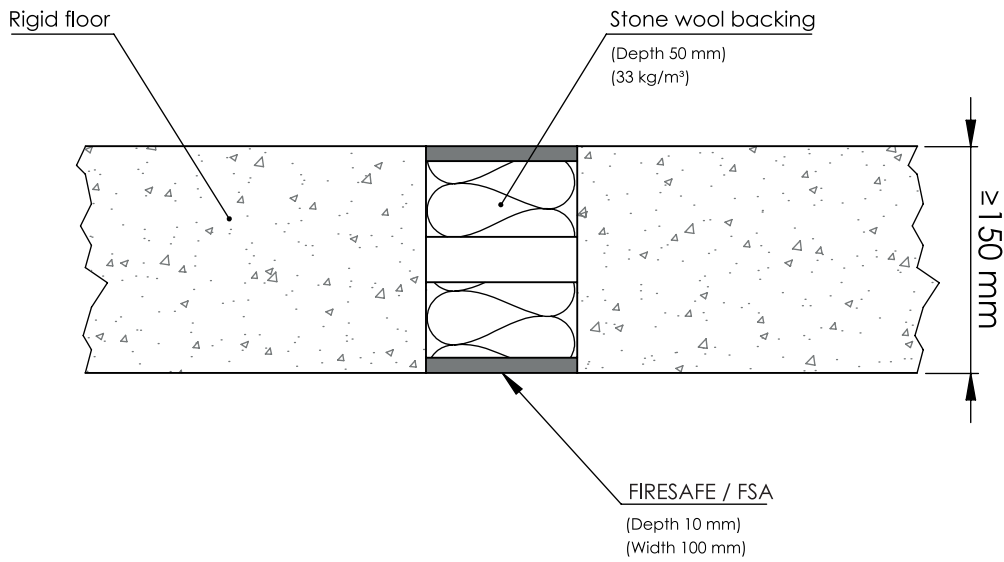
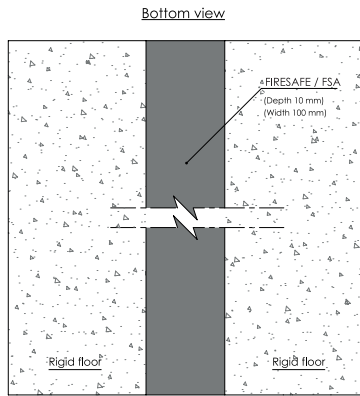

Drawing: RF-RF,E-MSP2.4.2.57

Construction	Width (mm)	Depth (mm)	Backing	Position	Classification
Rigid floor	≤ 100	≥ 10	≥ 50 mm stone wool (≥ 33 kg/m ³)	Both sides	EI 240 - H - X - F - W00 to W100